





7

BALL, GATE & SLIDE VALVES



PARKAIR®

			
411 Mini Flow Ball Valves	412 Full Flow Ball Valves	414 Check & Non-Return Valves	415 Bronze Valves







416 Ball Valves



		
417 Ball Valves	420 Bibcock Valves	421 3-Way Valves, Gate Valves & Accessories



		
422 Gas Approved Ball Valves	424 Check & Foot Valves	426 Y Strainers & Cartridges



427 Ball Valves



427 Safety Lock-Out Valves



428 Pneumatically Actuated Ball Valves



429 Ball & Slide Valves

PROCESS & CONTROL VALVES

Process and control valves regulate the flow of liquids or gases, controlling temperature, pressure, and liquid levels.

PARKAIR®

431 uPVC & ABS Ball Valves



AIGNEP

432 Full Flow Ball Valves & Accessories

PROCESS & CONTROL VALVES

HYDRAULIC VALVES

PARKAIR®

		
435 High Pressure Instrumental Ball Valves	437 High Pressure Instrumental Valves	438 Needle Valves

PARKAIR®



440 High Pressure Ball Valves

SOLENOID VALVES & ACCESSORIES



RÖTELMANN

441 Hydraulic Valves & Accessories

PARKAIR®

444 Line Mounted Valves

FESTO

	
445 Liquid / Media Solenoid & Diaphragm Valves	446 Liquid / Media Actuated Valves

PARKAIR®



	
448 Brass Solenoid Valves & Accessories	450 Stainless Steel Solenoid Valves & Accessories

PARKAIR®

		
451 Brass Solenoid Valves & Accessories	454 Stainless Steel Solenoid Valves & Accessories	455 IP65 Rated Coils & Omal VIP Co-Axial Flow Valves

SAFETY / RELIEF VALVES



		
456 Brass Solenoid Valves	458 Stainless Steel Solenoid Valves	458 Coils



	
460 Air Fuses	461 In-Line Preset Regulators



	
464 Atmospheric Discharge Valves	465 Pressure Relief Valves

PARKAIR®

467 Pressure Relief Valves



Ball Valves

A ball valve is a type of shut-off valve that regulates the flow of liquid or gas using a rotary ball. When the ball is rotated a quarter turn, the medium can either flow through or be blocked.

Ball valves are known for their reliability and efficiency in controlling water flow, isolating different sections of a plumbing system and assisting in maintenance and repairs.

The following pages showcase a variety of well-known brands, including Aignep, Itap, RuB, and Bonomi.

Types

- Full & reduced flow
- Heavy duty
- High pressure
- Gas approved
- Mini
- Venting lockable
- 3-way
- Full flow spring return
- Bibcock

Applications

- Water heaters
- Domestic appliances
- Pipe repair & maintenance
- Backflow prevention



STANDARD MINI BALL VALVES

APPLICATIONS

- Pneumatic, domestic & hydraulic installations
- Hot water
- Gasoline, fuel
- Oils, gas-oil
- Kerosene
- Acids
- Compressed air



2250

MINI

BSPP FEMALE

PART NUMBER	THREAD	PRESSURE	PRICE
B/V10-04	1/4" BSPP	15 bar	£6.96
B/V10-06	3/8" BSPP	15 bar	£8.13
B/V10-08	1/2" BSPP	15 bar	£9.68

SPECIFICATIONS

Temperature range -10°C to +90°C (14°F to 194°F)

MATERIALS

Ball valve	Brass
Handle	Plastic
Seal	PTFE



2250

MINI

BSPP MALE / BSPP FEMALE

PART NUMBER	THREAD	PRESSURE	PRICE
B/V11-04	1/4" BSPP	15 bar	£6.11
B/V11-06	3/8" BSPP	15 bar	£5.63
B/V11-08	1/2" BSPP	15 bar	£8.66

REDUCED BORE MINI BALL VALVES – STAINLESS STEEL

APPLICATIONS

- Pneumatic, domestic & hydraulic installations
- Hot water
- Gasoline, fuel
- Oils, gas-oil
- Kerosene
- Acids
- Compressed air



2220

REDUCED BORE MINI BALL VALVE

BSPP MALE / BSPP FEMALE

PART NUMBER	THREAD	WORKING PRESSURE	PRICE
SJ-B/V11-04	1/4" BSPP	1000 psi	£48.39
SJ-B/V11-06	3/8" BSPP	1000 psi	£50.13
SJ-B/V11-08	1/2" BSPP	1000 psi	£58.82

SPECIFICATIONS

Temperature range -50°C to +232°C (-58°F to +450°F)

Thread details ISO 228/1 BSPP

MATERIALS

Body & ball	CF8M/CF8
Seat	15% R-PTFE
Stem	304 stainless steel

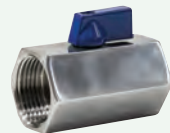

2220

REDUCED BORE MINI BALL VALVE

BSPP FEMALE

PART NUMBER	THREAD	WORKING PRESSURE	PRICE
SJ-B/V10-04	1/4" BSPP	1000 psi	£44.32
SJ-B/V10-06	3/8" BSPP	1000 psi	£45.76
SJ-B/V10-08	1/2" BSPP	1000 psi	£52.63

HIGH PRESSURE MINI BALL VALVES

FEATURES

- RoSH compliant
- Dual sealing system allows valve to be operated in either direction making installation easier
- No metal-to-metal moving parts
- No maintenance required
- Silicone-free lubricant on all seals
- Handle / stem clearly shows ball position



2255

HIGH PRESSURE WITH SCREWDRIVER SLOT

BSPP FEMALE

PART NUMBER	THREAD	PRESSURE	PRICE
B/V-S35BF3	1/4" BSPP	30 bar	£10.00
B/V-S35CF3	3/8" BSPP	30 bar	£10.00
B/V-S35DF3	1/2" BSPP	30 bar	£10.92

SPECIFICATIONS

Temperature range -20°C to +120°C (-4°F to +250°F)

MATERIALS

Ball valve	Brass
Handle	Reinforced nylon
Seal	PTFE



2255

HIGH PRESSURE WITH SCREWDRIVER SLOT

BSPP MALE / BSPP FEMALE

PART NUMBER	THREAD	PRESSURE	PRICE
B/V-S35AM3	1/8" BSPP	30 bar	£11.50
B/V-S35BM3	1/4" BSPP	30 bar	£10.00
B/V-S35CM3	3/8" BSPP	30 bar	£8.09
B/V-S35DM3	1/2" BSPP	30 bar	£10.92

FULL FLOW BALL VALVES

APPLICATIONS

- Pneumatic, domestic & hydraulic installations
- Hot water
- Gasoline, fuel
- Oils, gas-oil
- Kerosene
- Acids
- Compressed air

SPECIFICATIONS

Temperature range -10°C to +90°C (14°F to 194°F)

MATERIALS

Ball valve	Brass
Handle	Steel
Seal	PTFE



**FULL FLOW
BSPP FEMALE**

2250



**FULL FLOW
BSPP MALE / BSPP FEMALE**

2250

PART NUMBER	THREAD	PRESSURE	PRICE
B/V12-04	1/4" BSPP	25 bar	£9.77
B/V12-06	3/8" BSPP	25 bar	£9.50
B/V12-08	1/2" BSPP	25 bar	£12.64
B/V12-12	3/4" BSPP	25 bar	£14.66
B/V12-16	1" BSPP	25 bar	£23.42
B/V12-20	1 1/4" BSPP	25 bar	£38.34
B/V12-24	1 1/2" BSPP	25 bar	£58.14
B/V12-32	2" BSPP	25 bar	£106.46

PART NUMBER	THREAD	PRESSURE	PRICE
B/V14-04	1/4" BSPP	25 bar	£9.21
B/V14-06	3/8" BSPP	25 bar	£10.02
B/V14-08	1/2" BSPP	25 bar	£13.01
B/V14-12	3/4" BSPP	25 bar	£18.27
B/V14-16	1" BSPP	25 bar	£24.10
B/V14-20	1 1/4" BSPP	25 bar	£38.59
B/V14-24	1 1/2" BSPP	25 bar	£56.02
B/V14-32	2" BSPP	25 bar	£89.07

FULL FLOW GAS APPROVED BALL VALVE

APPLICATIONS

- Pneumatic, domestic & hydraulic installations
- Hot water
- Compressed air



SPECIFICATIONS

Max. pressure 1/4" – 2": 40 bar
Working temperature -20°C to +140°C (-4°F to +284°F)

SPECIFICATIONS – GAS DISTRIBUTION

Max. pressure 1/4" – 4": 5 bar
Working temperature -20°C to +60°C (-4°F to 140°F)

MATERIALS

Ball valve	Brass
Handle	Steel
Seal	PTFE



**FULL FLOW
BSPP FEMALE – GAS APPROVED**

2250



**FULL FLOW
BSPP MALE / BSPP FEMALE – GAS APPROVED**

2250

PART NUMBER	THREAD	PRESSURE	PRICE
B/V13-04	1/4" BSPP	40 bar	£9.85
B/V13-06	3/8" BSPP	40 bar	£9.85
B/V13-08	1/2" BSPP	40 bar	£14.00
B/V13-12	3/4" BSPP	40 bar	£19.76
B/V13-16	1" BSPP	40 bar	£30.59
B/V13-20	1 1/4" BSPP	40 bar	£48.37
B/V13-24	1 1/2" BSPP	40 bar	£72.75
B/V13-32	2" BSPP	40 bar	£110.55

PART NUMBER	THREAD	PRESSURE	PRICE
B/V15-04	1/4" BSPP	40 bar	£8.69
B/V15-06	3/8" BSPP	40 bar	£9.61
B/V15-08	1/2" BSPP	40 bar	£11.15
B/V15-12	3/4" BSPP	40 bar	£16.30
B/V15-16	1" BSPP	40 bar	£31.12
B/V15-20	1 1/4" BSPP	40 bar	£40.23
B/V15-24	1 1/2" BSPP	40 bar	£56.51
B/V15-32	2" BSPP	40 bar	£98.22

ONE & TWO PIECE SCREWED

SPECIFICATIONS	
Temperature range	-50°C to +232°C (60°F to 450°F)
MATERIALS	
Body	ASTM A-351 Gr.CF8M (DIN 1.4408)
Ball	316 stainless steel
Seat	PTFE
Stem	316 stainless steel
THREAD DETAILS	
ANSI B1.20.1 (NPT)	
DIN 259/DIN 2999	
ISO 228: BSP: PT	



ONE PIECE BALL VALVE
BSPP FEMALE
REDUCED BORE

2220

PART NUMBER	THREAD	WORKING PRESSURE	PRICE
SJ-V10-04	1/4" BSPP	55 bar	£26.57
SJ-V10-06	3/8" BSPP	55 bar	£26.57
SJ-V10-08	1/2" BSPP	55 bar	£30.58
SJ-V10-12	3/4" BSPP	55 bar	£37.82
SJ-V10-16	1" BSPP	55 bar	£49.52
SJ-V10-20	1 1/4" BSPP	55 bar	£78.67
SJ-V10-24	1 1/2" BSPP	55 bar	£94.52
SJ-V10-32	2" BSPP	55 bar	£138.92

THREE PIECE SCREWED & CHECK VALVE

SPECIFICATIONS	
Temperature range	-51°C to +232°C (-60°F to +450°F)
MATERIALS	
Body	ASTM A-351 Gr.CF8M (DIN 1.4408)
Ball	316 stainless steel
Seat	PTFE
Stem	316 stainless steel



THREE PIECE BALL VALVE
BSPP FEMALE
FULL FLOW

2220

PART NUMBER	THREAD	WORKING PRESSURE	PRICE
SJ-V30-04	1/4" BSPP	69 bar	£45.98
SJ-V30-06	3/8" BSPP	69 bar	£45.98
SJ-V30-08	1/2" BSPP	69 bar	£57.91
SJ-V30-12	3/4" BSPP	69 bar	£75.73
SJ-V30-16	1" BSPP	69 bar	£105.85
SJ-V30-20	1 1/4" BSPP	69 bar	£158.39
SJ-V30-24	1 1/2" BSPP	69 bar	£213.66
SJ-V30-32	2" BSPP	69 bar	£313.16



TWO PIECE BALL VALVE
BSPP FEMALE – FULL FLOW

2220

PART NUMBER	THREAD	WORKING PRESSURE	PRICE
SJ-V20-04	1/4" BSPP	69 bar	£31.41
SJ-V20-06	3/8" BSPP	69 bar	£31.41
SJ-V20-08	1/2" BSPP	69 bar	£38.96
SJ-V20-12	3/4" BSPP	69 bar	£49.99
SJ-V20-16	1" BSPP	69 bar	£76.40
SJ-V20-20	1 1/4" BSPP	69 bar	£109.62
SJ-V20-24	1 1/2" BSPP	69 bar	£148.97
SJ-V20-32	2" BSPP	69 bar	£228.91

Do you also need?

**PTFE lined
convoluted hose**

Find it on page 192, section four

FULL FLOW HEAVY DUTY BALL VALVES

FEATURES

- RoSH compliant
- 24 hour 100% seal test guaranteed
- Dual sealing system allows valve to be operated in either direction making installation easier
- No metal-to-metal moving parts
- Silicone-free lubricant on all seals
- Handle clearly shows ball position

SPECIFICATIONS

Temperature range -40°C to +170°C (-40°F to +350°F)

MATERIALS

Ball valve	Hot forged sandblasted, nickel plated brass
Handle	Geomet® carbon steel handle, thick PVC dip coating
Seal	PTFE



**FULL FLOW
BSPP FEMALE**

2255



**FULL FLOW
BSPP MALE / BSPP FEMALE**

2255

PART NUMBER	THREAD	PRESSURE	PRICE
B/V-S33B00	1/4" BSPP	65 bar	£16.18
B/V-S33C00	3/8" BSPP	65 bar	£16.18
B/V-S33D00	1/2" BSPP	65 bar	£19.74
B/V-S33E00	3/4" BSPP	65 bar	£31.32
B/V-S33F00	1" BSPP	65 bar	£50.60
B/V-S33G00	1 1/4" BSPP	40 bar	£72.68
B/V-S33H00	1 1/2" BSPP	40 bar	£102.08
B/V-S33I00	2" BSPP	40 bar	£159.16

PART NUMBER	THREAD	PRESSURE	PRICE
B/V-S33B20	1/4" BSPP	65 bar	£18.52
B/V-S33C20	3/8" BSPP	65 bar	£18.52
B/V-S33D20	1/2" BSPP	65 bar	£22.00
B/V-S33E20	3/4" BSPP	65 bar	£34.04
B/V-S33F20	1" BSPP	65 bar	£57.12
B/V-S33G20	1 1/4" BSPP	40 bar	£84.14
B/V-S33H20	1 1/2" BSPP	40 bar	£115.80
B/V-S33I20	2" BSPP	40 bar	£181.24

NON-RETURN VALVES – 316 STAINLESS STEEL

BENEFITS

Suitable for fuel systems

SPECIFICATIONS

Temperature range	-18°C to +70°C (0°F to 158°F)
Standard cracking point	0.5 bar

MATERIALS

SJ-V90 valves	316 stainless steel
Seals	FKM

NON-RETURN VALVE BSPP FEMALE



2220

PART NUMBER	THREAD	PRESSURE	PRICE
SJ-V90-02	1/8" BSPP	350 bar	£98.79
SJ-V90-04	1/4" BSPP	350 bar	£100.64
SJ-V90-06	3/8" BSPP	350 bar	£102.48
SJ-V90-08	1/2" BSPP	350 bar	£116.18
SJ-V90-12	3/4" BSPP	350 bar	£173.08
SJ-V90-16	1" BSPP	250 bar	£229.36
SJ-V90-20	1 1/4" BSPP	250 bar	£406.56
SJ-V90-24	1 1/2" BSPP	250 bar	£596.06
SJ-V90-32	2" BSPP	250 bar	£790.99

CHECK VALVE & Y STRAINER – 316 STAINLESS STEEL

MATERIALS

Body	ASTM A-351 Gr.CF8M (DIN 1.4408)
Ball & stem	316 stainless steel
Seat	PTFE



**SWING CHECK VALVE
BSPP FEMALE**

2220

PART NUMBER	THREAD	WORKING PRESSURE	PRICE
SJ-C10-08	1/2" BSPP	200 psi	£66.52
SJ-C10-12	3/4" BSPP	200 psi	£85.32
SJ-C10-16	1" BSPP	200 psi	£114.76
SJ-C10-20	1 1/4" BSPP	200 psi	£158.24
SJ-C10-24	1 1/2" BSPP	200 psi	£260.40
SJ-C10-32	2" BSPP	200 psi	£277.23

Y STRAINER BSPP FEMALE



2220

PART NUMBER	THREAD	PRICE
SJ-YS04	1/4" BSPP	£47.57
SJ-YS06	3/8" BSPP	£47.57
SJ-YS08	1/2" BSPP	£58.07
SJ-YS12	3/4" BSPP	£95.05
SJ-YS16	1" BSPP	£110.91

BRONZE BALL VALVE – LEVER OP

FEATURES

- Screwed BSP taper
- PTFE seats & seals
- Blow-out proof stem
- Full bore
- PN40 rated

SPECIFICATIONS

Maximum pressure	40 bar
Working temperature	-10°C to +140°C



ART 345

PN40 BSPT FEMALE

2240

PART NUMBER	THREAD	LENGTH	PRICE
aABRO345050	1/2" BSPT	55 mm	£27.40
aABRO345075	3/4" BSPT	62 mm	£34.97
aABRO345100	1" BSPT	73 mm	£44.86
aABRO345125	1 1/4" BSPT	83 mm	£87.89
aABRO345150	1 1/2" BSPT	92 mm	£109.38
aABRO345200	2" BSPT	107 mm	£169.12

BRONZE GLOBE VALVE – HANDWHEEL

FEATURES

- Screwed BSP taper
- Union bonnet
- PTFE renewable disc
- Bronze body
- Rising stem
- BS 5154 (BS EN12288)

SPECIFICATIONS

Maximum pressure	32 bar
Working temperature	-10°C to +200°C



ART 350

PN32 BSPT FEMALE

2240

PART NUMBER	THREAD	LENGTH	PRICE
aABRO350050	1/2" BSPT	57.0 mm	£67.73
aABRO350075	3/4" BSPT	67.0 mm	£99.52
aABRO350100	1" BSPT	76.5 mm	£144.05
aABRO350125	1 1/4" BSPT	88.0 mm	£200.21
aABRO350150	1 1/2" BSPT	102.5 mm	£299.04
aABRO350200	2" BSPT	121.5 mm	£455.35

BRONZE GATE VALVE – HANDWHEEL

FEATURES

- Screwed BSP taper
- PN20 5154 (BS EN12288)
- Bronze body & disc
- Screwed bonnet

SPECIFICATIONS

Maximum pressure	20 bar
Working temperature	-10°C to +180°C



ART 375HW

PN20 BSPT FEMALE

2240

PART NUMBER	THREAD	LENGTH	PRICE
aABRO375HW050	1/2" BSPT	47.5 mm	£39.22
aABRO375HW075	3/4" BSPT	51.5 mm	£48.45
aABRO375HW100	1" BSPT	58.6 mm	£66.81
aABRO375HW125	1 1/4" BSPT	63.0 mm	£90.45
aABRO375HW150	1 1/2" BSPT	66.5 mm	£118.56
aABRO375HW200	2" BSPT	73.5 mm	£180.02

BRONZE GATE VALVE – LOCKSHIELD

FEATURES

- Screwed BSP taper
- PN20 rated
- Screwed bonnet
- Bronze body & disc
- BS 5154 (BS EN12288)
- Lock shield

SPECIFICATIONS

Maximum pressure	20 bar
Working temperature	-10°C to +180°C



ART 375LS

PN20 BSPT FEMALE

2240

PART NUMBER	THREAD	LENGTH	PRICE
aABRO375LS050	1/2" BSPT	47.5 mm	£40.81
aABRO375LS075	3/4" BSPT	51.5 mm	£50.43
aABRO375LS100	1" BSPT	58.6 mm	£69.48
aABRO375LS125	1 1/4" BSPT	63.0 mm	£94.07
aABRO375LS150	1 1/2" BSPT	66.5 mm	£123.25
aABRO375LS200	2" BSPT	73.5 mm	£187.23

BRONZE Y TYPE STRAINER

FEATURES

- Screwed BSP taper
- Screwed cap
- PN20 rated
- Bronze body
- Standard screen 0.75 mm perforations



ART 368

PN20 BSPT FEMALE

2240

PART NUMBER	THREAD	LENGTH	PRICE
aABRO368050	1/2" BSPT	80 mm	£37.08
aABRO368075	3/4" BSPT	100 mm	£49.39
aABRO368100	1" BSPT	115 mm	£77.27
aABRO368125	1 1/4" BSPT	135 mm	£112.04
aABRO368150	1 1/2" BSPT	160 mm	£145.84
aABRO368200	2" BSPT	190 mm	£237.64

BRONZE SWING CHECK VALVE

FEATURES

- Screwed BSP taper
- Bronze disc
- BS 5154 (BS EN12288)
- Bronze body
- PN20 rated



ART 384

PN20 BSPT FEMALE

2240

PART NUMBER	THREAD	LENGTH	PRICE
aABRO384050	1/2" BSPT	56.0 mm	£34.89
aABRO384075	3/4" BSPT	70.5 mm	£47.39
aABRO384100	1" BSPT	80.0 mm	£63.06
aABRO384125	1 1/4" BSPT	96.5 mm	£88.78
aABRO384150	1 1/2" BSPT	110.0 mm	£116.58
aABRO384200	2" BSPT	129.0 mm	£176.67

FULL FLOW BALL VALVES

FEATURES

- RoSH compliant
- 24 hour 100% seal test guaranteed
- Dual sealing system allows valve to be operated in either direction making installation easier
- No metal-to-metal moving parts
- No maintenance ever required
- Silicone-free lubricant on all seals
- Handle clearly shows ball position
- Handle stops on body to avoid stresses at stem
- Chrome plated DZR brass ball for longer life
- Dezincification resistant ADZ-T & ADZ-P brass approved to SBN- PFS 1983:2 & NR-BFS 1988:18 specifications

SPECIFICATIONS

Temperature range -20°C to +120°C (-4°F to +250°F)

MATERIALS

Ball valve	Hot forged sandblasted, DZR unplated brass
Handle	Geomet® carbon steel handle, thick PVC dip coating
Seal	PTFE



DEZINCIFICATION RESISTANT

FEMALE COMPRESSION ENDS

2255

PART NUMBER	TUBE OD	PRESSURE	PRICE
B/V-S28C12	12 mm	16 bar	£29.94
B/V-S28D15	15 mm	16 bar	£30.24
B/V-S28D18	18 mm	16 bar	£35.88
B/V-S28E22	22 mm	16 bar	£40.14
B/V-S28F28	28 mm	16 bar	£57.88
B/V-S28G35	35 mm	16 bar	£101.20
B/V-S28H42	42 mm	16 bar	£148.58
B/V-S28I54	54 mm	16 bar	£242.59

FULL FLOW SPRING RETURN BALL VALVES

FEATURES

- RoSH compliant
- 24 hour 100% seal test guaranteed
- Dual sealing system allows valve to be operated in either direction making installation easier
- No metal-to-metal moving parts
- No maintenance ever required
- Silicone-free lubricant on all seals
- Handle clearly shows ball position
- Travel stops on body to avoid stresses at stem
- Chrome plated brass ball for longer life with rinse hole

SPECIFICATIONS

Temperature range -40°C to +170°C (-40°F to +350°F)

MATERIALS

Ball valve	Hot forged sandblasted, external nickel plated brass
Handle	Geomet® carbon steel handle, thick PVC dip coating
Seal	PTFE



SPRING RETURN BSPP FEMALE

2255

PART NUMBER	THREAD	PRESSURE	PRICE
B/V-S84B00M	1/4" BSPP	40 bar	£32.62
B/V-S84C00M	3/8" BSPP	40 bar	£32.62
B/V-S84D00M	1/2" BSPP	40 bar	£32.62
B/V-S84E00M	3/4" BSPP	40 bar	£43.70
B/V-S84F00M	1" BSPP	40 bar	£60.22
B/V-S84G00M	1 1/4" BSPP	40 bar	£103.71
B/V-S84H00M	1 1/2" BSPP	40 bar	£122.15
B/V-S84I00M	2" BSPP	40 bar	£183.66

VENTING LOCKABLE BALL VALVES

DESCRIPTION

Valve is lockable in the closed position only, according to Part. 1910.147 safety OSHA (USA) requirements, allowing safe maintenance of the air supplied equipment; when valve is open, one simple 90° turn of the handle shuts flow immediately.

FEATURES

- Patented tamper proof, lockable handle
- Exhausts automatically & continuously downstream air pressure as soon as turned in the closed position



VENTING LOCKABLE BALL VALVE BSPP FEMALE BRASS

2255

PART NUMBER	THREAD	PRESSURE	PRICE
B/V-VBL-04	1/4" BSPP	14 bar	£21.54
B/V-VBL-06	3/8" BSPP	14 bar	£21.54
B/V-VBL-08	1/2" BSPP	14 bar	£23.88
B/V-VBL-12	3/4" BSPP	14 bar	£31.99
B/V-VBL-16	1" BSPP	14 bar	£50.26
B/V-VBL-20	1 1/4" BSPP	14 bar	£129.22
B/V-VBL-24	1 1/2" BSPP	14 bar	£169.91
B/V-VBL-32	2" BSPP	14 bar	£264.50

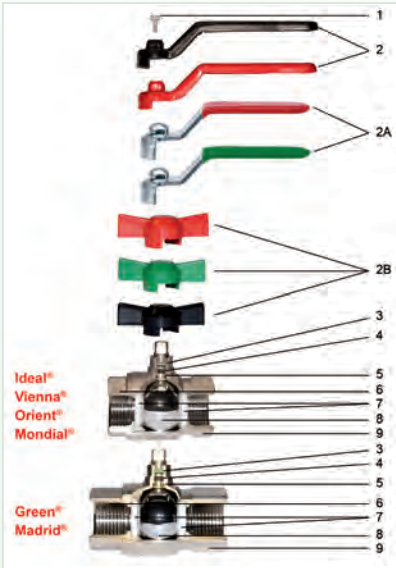

CROSS SECTION & MATERIALS FOR: GREEN®, IDEAL®, VIENNA® & ORIENT® VALVE RANGES

DESCRIPTION	MATERIAL
1 Screw	Fe CB4 zinc plated steel
2 Lever handle	Fe. P. 04 zinc plated & varnished steel
2A Flat lever handle	Fe. P. 04 zinc plated & plastic coated steel
2B T handle	Aluminium
3 O-ring	FKM 70 SH/A
4 O-ring	NBR 70 SH/A
5 Stem	Brass CW614N
6 End adaptor	Nickel plated brass CW617N
7 Seal	Pure PTFE
8 Ball	Chrome plated brass CW617N
9 Body	Nickel plated brass CW617N



FULL FLOW ECOLOGICAL BALL VALVES – GREEN®

DESCRIPTION

Ecological ball valves in compliance with the new European regulation for drinkable water. Approved in accordance with standard EN 13828 & Code of Practice DVGW W 570 for the distribution of water intended for human consumption. Equipped with a ball design to avoid the stagnation of water & eventual proliferation of bacteria inside the valve.

SPECIFICATIONS

Temperature range -20°C to +150°C (-4°F to +302°F) in absence of steam

MATERIALS

Body Nickel plated brass CW617N
Flat lever handle Zinc plated & plastic coated steel Fe. P.04
T handle Aluminium

GREEN® FULL FLOW BSPP FEMALE – ISO 7/1



2200

GREEN® FULL FLOW BSPT MALE / BSPP FEMALE – ISO 7/1



2200

PART NUMBER	THREAD	PRESSURE	PRICE
● B/V2376-04	1/4" BSPP	50 bar	£10.05
● B/V2376-06	3/8" BSPP	50 bar	£10.53
● B/V2376-08	1/2" BSPP	50 bar	£14.56
● B/V2376-12	3/4" BSPP	40 bar	£19.70
● B/V2376-16	1" BSPP	40 bar	£29.98
B/V2376-20	1 1/4" BSPP	30 bar	£53.33
B/V2376-24	1 1/2" BSPP	30 bar	£84.77
B/V2376-32	2" BSPP	25 bar	£117.62

PART NUMBER	THREAD	THREAD	PRESSURE	PRICE
● B/V2377-04	1/4" BSPT	1/4" BSPP	50 bar	£10.65
● B/V2377-06	3/8" BSPT	3/8" BSPP	50 bar	£11.41
● B/V2377-08	1/2" BSPT	1/2" BSPP	50 bar	£15.36
● B/V2377-12	3/4" BSPT	3/4" BSPP	40 bar	£20.57
● B/V2377-16	1" BSPT	1" BSPP	40 bar	£31.50
B/V2377-20	1 1/4" BSPT	1 1/4" BSPP	30 bar	£55.90
B/V2377-24	1 1/2" BSPT	1 1/2" BSPP	30 bar	£86.98
B/V2377-32	2" BSPT	2" BSPP	25 bar	£119.92

GREEN® FULL FLOW T HANDLE BSPP FEMALE – ISO 7/1



2200

GREEN® FULL FLOW T HANDLE BSPT MALE / BSPP FEMALE – ISO 7/1



2200

PART NUMBER	THREAD	PRESSURE	PRICE
B/V2378-04	1/4" BSPP	50 bar	£9.56
B/V2378-06	3/8" BSPP	50 bar	£10.15
B/V2378-08	1/2" BSPP	50 bar	£14.15
B/V2378-12	3/4" BSPP	40 bar	£19.07
B/V2378-16	1" BSPP	40 bar	£29.37

PART NUMBER	THREAD	THREAD	PRESSURE	PRICE
B/V2379-04	1/4" BSPT	1/4" BSPP	50 bar	£10.17
B/V2379-06	3/8" BSPT	3/8" BSPP	50 bar	£11.06
B/V2379-08	1/2" BSPT	1/2" BSPP	50 bar	£14.98
B/V2379-12	3/4" BSPT	3/4" BSPP	40 bar	£20.01
B/V2379-16	1" BSPT	1" BSPP	40 bar	£30.92

MINI BALL VALVES

DESCRIPTION

Suitable for domestic water services, heating & air conditioning plants, & compressed air systems

SPECIFICATIONS

Temperature range 0°C to 90°C (32°F to 194°F)

MATERIALS

Body Nickel plated brass
Lever handle Nylon



MINI BSPP FEMALE – ISO228

MINI BSPP MALE / BSPP FEMALE ISO228

PART NUMBER	THREAD	PRESSURE	PRICE
B/V2125-02	1/8" BSPP	10 bar	£8.19
B/V2125-04	1/4" BSPP	10 bar	£8.19
B/V2125-06	3/8" BSPP	10 bar	£7.86
B/V2125-08	1/2" BSPP	10 bar	£9.90
B/V2125-12	3/4" BSPP	10 bar	£14.63

PART NUMBER	THREAD	PRESSURE	PRICE
B/V2126-02	1/8" BSPP	10 bar	£7.52
B/V2126-04	1/4" BSPP	10 bar	£7.35
B/V2126-06	3/8" BSPP	10 bar	£7.13
B/V2126-08	1/2" BSPP	10 bar	£8.98
B/V2126-12	3/4" BSPP	10 bar	£14.99

FULL FLOW BALL VALVES – IDEAL®

DESCRIPTION

Suitable for domestic water services, heating & air conditioning plants, & compressed air systems.

SPECIFICATIONS

Temperature range -20°C to +150°C (-4°F to +302°F)

MATERIALS

Body Nickel plated brass
Lever handle 1/4" to 2" Steel
2 1/2", 3" & 4" Aluminium
T handle Aluminium



IDEAL® FULL FLOW BSPP FEMALE – ISO228

IDEAL® FULL FLOW BSPP MALE / BSPP FEMALE – ISO228

PART NUMBER	THREAD	PRESSURE	PRICE
B/V2090-04	1/4" BSPP	50 bar	£8.90
B/V2090-06	3/8" BSPP	50 bar	£9.07
B/V2090-08	1/2" BSPP	50 bar	£11.30
B/V2090-12	3/4" BSPP	40 bar	£16.62
B/V2090-16	1" BSPP	40 bar	£25.29
B/V2090-20	1 1/4" BSPP	30 bar	£39.63
B/V2090-24	1 1/2" BSPP	30 bar	£59.61
B/V2090-32	2" BSPP	25 bar	£91.95
B/V2090-40	2 1/2" BSPP	18 bar	£215.24
B/V2090-48	3" BSPP	16 bar	£335.23
B/V2090-64	4" BSPP	14 bar	£553.87

PART NUMBER	THREAD	PRESSURE	PRICE
B/V2091-04	1/4" BSPP	50 bar	£9.71
B/V2091-06	3/8" BSPP	50 bar	£10.24
B/V2091-08	1/2" BSPP	50 bar	£12.37
B/V2091-12	3/4" BSPP	40 bar	£18.02
B/V2091-16	1" BSPP	40 bar	£27.27
B/V2091-20	1 1/4" BSPP	30 bar	£43.66
B/V2091-24	1 1/2" BSPP	30 bar	£64.00
B/V2091-32	2" BSPP	25 bar	£98.48

IDEAL® FULL FLOW T HANDLE BSPP FEMALE – ISO228

IDEAL® FULL FLOW T HANDLE BSPP MALE / BSPP FEMALE – ISO228

PART NUMBER	THREAD	PRESSURE	PRICE
B/V2092-04	1/4" BSPP	50 bar	£8.70
B/V2092-06	3/8" BSPP	50 bar	£8.88
B/V2092-08	1/2" BSPP	50 bar	£11.12
B/V2092-12	3/4" BSPP	40 bar	£16.02
B/V2092-16	1" BSPP	40 bar	£24.92
B/V2092-20	1 1/4" BSPP	30 bar	£40.34

PART NUMBER	THREAD	PRESSURE	PRICE
B/V2093-04	1/4" BSPP	50 bar	£9.60
B/V2093-06	3/8" BSPP	50 bar	£10.14
B/V2093-08	1/2" BSPP	50 bar	£12.17
B/V2093-12	3/4" BSPP	40 bar	£17.57
B/V2093-16	1" BSPP	40 bar	£26.92
B/V2093-20	1 1/4" BSPP	30 bar	£44.69

IDEAL® STRAIGHT FULL FLOW BSPP MALE / BSPP FEMALE – ISO228

IDEAL® 90° FULL FLOW BSPP MALE / BSPP FEMALE – ISO228

PART NUMBER	THREAD	PRESSURE	PRICE
B/V2098-08	1/2" BSPP	50 bar	£15.08
B/V2098-12	3/4" BSPP	40 bar	£22.44
B/V2098-16	1" BSPP	40 bar	£34.58
B/V2098-20	1 1/4" BSPP	30 bar	£54.35

PART NUMBER	THREAD	PRESSURE	PRICE
B/V2298-08	1/2" BSPP	50 bar	£18.32
B/V2298-12	3/4" BSPP	40 bar	£28.23
B/V2298-16	1" BSPP	40 bar	£43.48

STANDARD FLOW BALL VALVES – VIENNA®

FEATURES

Suitable for domestic water services, heating & air-conditioning plants, & compressed air systems.



2200

VIENNA® STANDARD FLOW BSPP FEMALE – ISO228

PART NUMBER	THREAD	PRESSURE	PRICE
● B/V2216-04	1/4" BSPP	50 bar	£9.35
● B/V2216-06	3/8" BSPP	50 bar	£9.52
● B/V2216-08	1/2" BSPP	30 bar	£10.47
● B/V2216-12	3/4" BSPP	30 bar	£15.08
● B/V2216-16	1" BSPP	30 bar	£22.17
● B/V2216-20	1 1/4" BSPP	25 bar	£35.80
● B/V2216-24	1 1/2" BSPP	25 bar	£50.08
● B/V2216-32	2" BSPP	25 bar	£82.39

SPECIFICATIONS

Temperature range	-20°C to +150°C (-4°F to +302°F) in absence of steam
-------------------	---------------------------------------------------------

MATERIALS

Body	Nickel plated brass
Flat lever handle	Lined steel

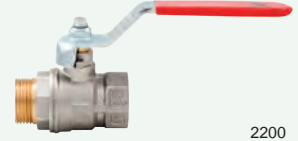

2200

VIENNA® STANDARD FLOW BSPP MALE / BSPP FEMALE – ISO228

PART NUMBER	THREAD	PRESSURE	PRICE
● B/V2217-04	1/4" BSPP	50 bar	£10.15
● B/V2217-06	3/8" BSPP	50 bar	£10.67
● B/V2217-08	1/2" BSPP	30 bar	£11.81
● B/V2217-12	3/4" BSPP	30 bar	£16.62
● B/V2217-16	1" BSPP	30 bar	£24.62
● B/V2217-20	1 1/4" BSPP	25 bar	£39.57
● B/V2217-24	1 1/2" BSPP	25 bar	£54.41
● B/V2217-32	2" BSPP	25 bar	£90.16

REDUCED FLOW BALL VALVES – ORIENT®

DESCRIPTION

Suitable for domestic water services, heating & air conditioning plants, & compressed air systems.



2200

ORIENT® REDUCED FLOW BSPP FEMALE – ISO228

PART NUMBER	THREAD	PRESSURE	PRICE
● B/V2111-08	1/2" BSPP	50 bar	£10.09
● B/V2111-12	3/4" BSPP	40 bar	£14.49
● B/V2111-16	1" BSPP	40 bar	£18.91
● B/V2111-20	1 1/4" BSPP	30 bar	£29.17
● B/V2111-24	1 1/2" BSPP	30 bar	£43.17

SPECIFICATIONS

Temperature range	-20°C to +150°C (-4°F to +302°F) in absence of steam
-------------------	---------------------------------------------------------

MATERIALS

Body	Nickel plated brass
Lever handle	Steel
T handle	Aluminium



2200

ORIENT® REDUCED FLOW BSPP MALE / BSPP FEMALE – ISO228

PART NUMBER	THREAD	PRESSURE	PRICE
● B/V2112-08	1/2" BSPP	50 bar	£11.50
● B/V2112-12	3/4" BSPP	40 bar	£16.48
● B/V2112-16	1" BSPP	40 bar	£22.35

ORIENT® REDUCED FLOW T HANDLE BSPP FEMALE – ISO228



2200

PART NUMBER	THREAD	PRESSURE	PRICE
B/V2113-08	1/2" BSPP	50 bar	£10.00
B/V2113-12	3/4" BSPP	40 bar	£14.40
B/V2113-16	1" BSPP	40 bar	£18.47

ORIENT® REDUCED FLOW T HANDLE BSPP MALE / BSPP FEMALE – ISO228



2200

PART NUMBER	THREAD	PRESSURE	PRICE
B/V2114-08	1/2" BSPP	50 bar	£11.31
B/V2114-12	3/4" BSPP	40 bar	£16.38
B/V2114-16	1" BSPP	40 bar	£21.90

BALL VALVES

DESCRIPTION

Suitable for domestic water services, heating & air conditioning plants, & compressed air systems.

SPECIFICATIONS

Min. working temperature	-20°C to +110°C (-4°F to +230°F) in absence of steam
--------------------------	---------------------------------------------------------

MATERIALS

Body	Nickel plated brass
Handle	Steel



2200

STANDARD FLOW WITH DRAIN VALVE BSPP FEMALE – ISO228

PART NUMBER	THREAD	PRESSURE	PRICE
B/V2115-08	1/2" BSPP	25 bar	£16.71
B/V2115-12	3/4" BSPP	25 bar	£22.51
B/V2115-16	1" BSPP	25 bar	£29.93
B/V2115-20	1 1/4" BSPP	20 bar	£50.15
B/V2115-24	1 1/2" BSPP	20 bar	£66.80
B/V2115-32	2" BSPP	20 bar	£100.96

SPECIFICATIONS

Min. working temperature	-10°C to +95°C (14°F to 203°F) in absence of steam
--------------------------	-------------------------------------------------------

MATERIALS

Body	Nickel plated brass
Handle	Aluminium



2200

FULL FLOW BSPP MALE – ISO228

PART NUMBER	THREAD	PRESSURE	PRICE
B/V2099-08	1/2" BSPP	40 bar	£13.72
B/V2099-12	3/4" BSPP	40 bar	£18.32
B/V2099-16	1" BSPP	40 bar	£28.24
B/V2099-20	1 1/4" BSPP	30 bar	£42.88
B/V2099-24	1 1/2" BSPP	30 bar	£70.90
B/V2099-32	2" BSPP	30 bar	£106.05

BIBCOCK VALVES

DESCRIPTION

Suitable for domestic water services & heating plants.



2200

BIBCOCK BSPP MALE / HOSETAIL – ISO228

PART NUMBER	THREAD	HOSE ID	PRESSURE	PRICE
B/V2132-06	3/8" BSPP	10 mm	15 bar	£16.07
B/V2132-08	1/2" BSPP	13 mm	15 bar	£15.81
B/V2132-12	3/4" BSPP	20 mm	15 bar	£23.02
B/V2132-16	1" BSPP	25 mm	12 bar	£34.48

SPECIFICATIONS

Temperature range	-20°C to +80°C (-4°F to +176°F)
-------------------	---------------------------------

MATERIALS

Body	Nickel plated brass
Hose connection	Brass
B/V2132 handle	Steel
B/V2133 handle	Lined steel
B/V2134 handle	Aluminium
B/V2144 handle	Steel



2200

BIBCOCK BSPP MALE / HOSETAIL – ISO228

PART NUMBER	THREAD	HOSE ID	PRESSURE	PRICE
B/V2133-08	1/2" BSPP	13 mm	15 bar	£16.40
B/V2133-12	3/4" BSPP	20 mm	15 bar	£23.85

BIBCOCK T HANDLE

BSPP MALE / HOSETAIL – ISO228



2200

PART NUMBER	THREAD	HOSE ID	PRESSURE	PRICE
B/V2134-06	3/8" BSPP	10 mm	15 bar	£16.02
B/V2134-08	1/2" BSPP	13 mm	15 bar	£15.76
B/V2134-12	3/4" BSPP	20 mm	15 bar	£23.01
B/V2134-16	1" BSPP	25 mm	12 bar	£35.15



2200

LOCKABLE BIBCOCK BSPP MALE / HOSETAIL – ISO228

PART NUMBER	THREAD	HOSE ID	PRESSURE	PRICE
B/V2144-08	1/2" BSPP	13 mm	15 bar	£24.88
B/V2144-12	3/4" BSPP	20 mm	15 bar	£26.83

HOSE CONNECTION

CHROME PLATED BRASS

BSPP MALE / HOSETAIL – ISO228



2200

PART NUMBER	THREAD	HOSE ID	PRICE
B/V2280-12	3/4" BSPP	20 mm	£2.08
B/V2280-16	1" BSPP	25 mm	£3.57
B/V2280-20	1 1/4" BSPP	32 mm	£7.19

HOSE CONNECTION

NYLON

BSPP MALE / HOSETAIL – ISO228



2200

PART NUMBER	THREAD	HOSE ID	PRICE
B/V2282-12	3/4" BSPP	20 mm	£1.08
B/V2282-16	1" BSPP	25 mm	£1.64

3-WAY VALVES

DESCRIPTION

Suitable for domestic water services, heating & air conditioning plants, & compressed air systems.



**3-WAY L PORT
BSPP FEMALE**

2200

PART NUMBER	THREAD	PRESSURE	PRICE
B/V2128-04L	1/4" BSPP	55 bar	£66.02
B/V2128-06L	3/8" BSPP	55 bar	£66.02
B/V2128-08L	1/2" BSPP	50 bar	£66.02
B/V2128-12L	3/4" BSPP	50 bar	£101.10
B/V2128-16L	1" BSPP	45 bar	£148.07
B/V2128-20L	1 1/4" BSPP	35 bar	£227.49
B/V2128-24L	1 1/2" BSPP	35 bar	£315.61
B/V2128-32L	2" BSPP	35 bar	£483.82

SPECIFICATIONS

Min. working temperature -10°C to +120°C (14°F to 248°F) in absence of steam

MATERIALS

Body Nickel plated brass
Lever handle Aluminium

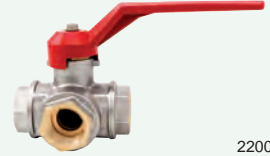

**3-WAY T PORT
BSPP FEMALE**

2200

PART NUMBER	THREAD	PRESSURE	PRICE
B/V2128-04T	1/4" BSPP	55 bar	£66.02
B/V2128-06T	3/8" BSPP	55 bar	£66.02
B/V2128-08T	1/2" BSPP	50 bar	£66.02
B/V2128-12T	3/4" BSPP	50 bar	£101.10
B/V2128-16T	1" BSPP	45 bar	£148.07
B/V2128-20T	1 1/4" BSPP	35 bar	£227.49
B/V2128-24T	1 1/2" BSPP	35 bar	£315.61
B/V2128-32T	2" BSPP	35 bar	£483.82

GATE VALVES & HANDLES

DESCRIPTION

Suitable for domestic water services, heating, & air conditioning plants.



2200

**GATE VALVE
BSPP FEMALE**

PART NUMBER	THREAD	PRESSURE	PRICE
B/V2156-08	1/2" BSPP	16 bar	£17.96
B/V2156-12	3/4" BSPP	16 bar	£25.19
B/V2156-16	1" BSPP	16 bar	£34.07
B/V2156-20	1 1/4" BSPP	16 bar	£45.10
B/V2156-24	1 1/2" BSPP	16 bar	£58.97
B/V2156-32	2" BSPP	16 bar	£88.34
B/V2156-40	2 1/2" BSPP	16 bar	£155.93
B/V2156-48	3" BSPP	16 bar	£213.14
B/V2156-64	4" BSPP	16 bar	£383.55

SPECIFICATIONS

Temperature range 0°C to 150°C (32°F to 302°F) in absence of steam

MATERIALS

Body B/V2156-08 Brass
Handle Aluminium



2200

**HANDLES
RED**

PART NUMBER	FOR USE WITH	PRICE
B/VOLA050	1/2"	£2.38
B/VOLA060	3/4", 1"	£2.60
B/VOLA070	1 1/4", 1 1/2"	£4.14
B/VOLA080	2"	£4.82
B/VOLA100	2 1/2", 3"	£15.08
B/VOLA120	4"	£18.91

LOCKING DEVICE FOR LOCKABLE FLAT LEVER HANDLES

DESCRIPTION

This device can be used on valves & bibcocks with flat lever handles.

SERIES	1/4"	3/8"	1/2"	3/4"	1"	1 1/4"
2111 / 2112	-	-	1	2	3	3
2090 / 2091	1	1	1	3	3	-
2216 / 2217	1	1	1	3	3	-
2132	-	1	1	2	2	-
2133	-	-	1	2	-	-
2066 / 2067	1	1	2	3	3	-
2266 / 2267	1	1	2	3	3	-
2376 / 2377	1	1	2	3	3	-



2200

LOCKING DEVICE

PART NUMBER	SIZE	COLOUR CODE	PRICE
B/V084LK01	1	●	£2.73
B/V084LK02	2	●	£3.00
B/V084LK03	3	●	£3.33

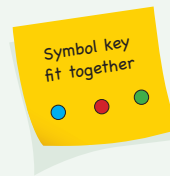

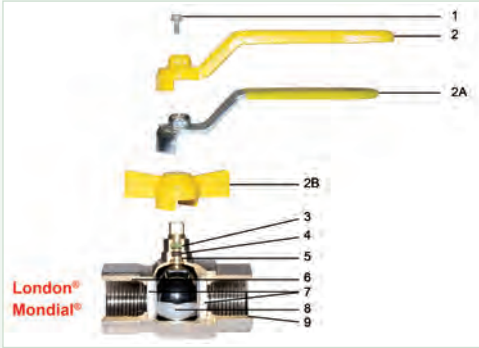

CROSS SECTION & MATERIALS FOR: LONDON® VALVE RANGES

DESCRIPTION	MATERIAL
1 Screw	Fe CB4 zinc plated steel
2 Lever handle	Fe. P. 04 zinc plated & varnished steel
2A Flat lever handle in lined steel	Fe. P. 04 zinc plated steel
2B T handle	Aluminium
3 O-ring	FKM 70 SH/A
4 O-ring	NBR 70 SH/A
5 Stem	Brass CW614N
6 Body	Nickel plated brass CW617N
7 Seal	Pure PTFE
8 Ball	Chrome plated brass CW617N
9 End adaptor	Nickel plated brass CW617N

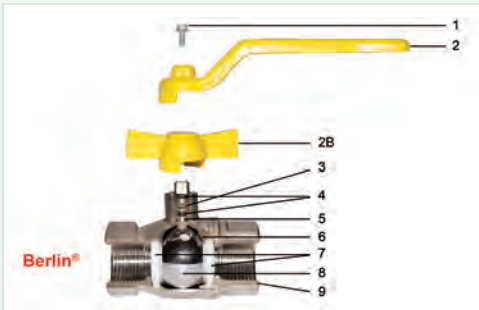

CROSS SECTION & MATERIALS FOR: BERLIN® VALVE RANGES

DESCRIPTION	MATERIAL
1 Screw	Fe CB4 zinc plated steel
2 Lever handle	Fe. P. 04 zinc plated & varnished steel
2B T handle	Aluminium
3 O-ring	FKM 70 SH/A
4 O-ring	NBR 70 SH/A
5 Stem	Brass CW614N
6 Body	Nickel plated brass CW617N
7 Seal	Pure PTFE
8 Ball	Chrome plated brass CW617N
9 End adaptor	Nickel plated brass CW617N

FULL FLOW GAS BALL VALVES – LONDON®

SPECIFICATIONS	
Temperature range	-20°C to +60°C (-4°F to +140°F)

See page 421
for compatible
locking device

MATERIALS	
Body	Nickel plated brass
2066, 2067 lever handle	Steel
2068, 2069 T handle	Aluminium
2120G, 2121G lever handle	Aluminium
2266, 2067 flat lever handle	Lined steel

LONDON® FULL FLOW BSPP FEMALE – ISO7/1



2200

LONDON® FULL FLOW BSPT MALE / BSPP FEMALE – ISO7/1



2200

PART NUMBER	THREAD	PRESSURE	PRICE
● B/V2066-04	1/4" BSPP	5 bar	£9.43
● B/V2066-06	3/8" BSPP	5 bar	£10.00
● B/V2066-08	1/2" BSPP	5 bar	£14.22
● B/V2066-12	3/4" BSPP	5 bar	£19.52
● B/V2066-16	1" BSPP	5 bar	£29.46
● B/V2066-20	1 1/4" BSPP	5 bar	£48.52
● B/V2066-24	1 1/2" BSPP	5 bar	£76.65
● B/V2066-32	2" BSPP	5 bar	£107.32

PART NUMBER	THREAD	THREAD	PRESSURE	PRICE
● B/V2067-04	1/4" BSPT	1/4" BSPP	5 bar	£10.02
● B/V2067-06	3/8" BSPT	3/8" BSPP	5 bar	£10.87
● B/V2067-08	1/2" BSPT	1/2" BSPP	5 bar	£15.02
● B/V2067-12	3/4" BSPT	3/4" BSPP	5 bar	£20.39
● B/V2067-16	1" BSPT	1" BSPP	5 bar	£30.95
● B/V2067-20	1 1/4" BSPT	1 1/4" BSPP	5 bar	£51.09
● B/V2067-24	1 1/2" BSPT	1 1/2" BSPP	5 bar	£79.16
● B/V2067-32	2" BSPT	2" BSPP	5 bar	£109.95

LONDON® FULL FLOW T HANDLE BSPP FEMALE – ISO7/1



2200

LONDON® FULL FLOW T HANDLE BSPT MALE / BSPP FEMALE – ISO7/1



2200

PART NUMBER	THREAD	PRESSURE	PRICE
B/V2068-04	1/4" BSPP	5 bar	£9.31
B/V2068-06	3/8" BSPP	5 bar	£9.89
B/V2068-08	1/2" BSPP	5 bar	£13.98
B/V2068-12	3/4" BSPP	5 bar	£19.06
B/V2068-16	1" BSPP	5 bar	£28.86

PART NUMBER	THREAD	THREAD	PRESSURE	PRICE
B/V2069-04	1/4" BSPT	1/4" BSPP	5 bar	£9.91
B/V2069-06	3/8" BSPT	3/8" BSPP	5 bar	£10.76
B/V2069-08	1/2" BSPT	1/2" BSPP	5 bar	£14.77
B/V2069-12	3/4" BSPT	3/4" BSPP	5 bar	£19.98
B/V2069-16	1" BSPT	1" BSPP	5 bar	£30.35

FULL FLOW GAS BALL VALVES – LONDON®

LONDON® FULL FLOW FLAT HANDLE BSPP FEMALE – ISO7/1



2200

LONDON® FULL FLOW FLAT HANDLE BSPP MALE / BSPP FEMALE – ISO7/1



2200

PART NUMBER	THREAD	PRESSURE	PRICE
B/V2266-04	1/4" BSPP	5 bar	£10.04
B/V2266-06	3/8" BSPP	5 bar	£10.61
B/V2266-08	1/2" BSPP	5 bar	£14.72
B/V2266-12	3/4" BSPP	5 bar	£19.98
B/V2266-16	1" BSPP	5 bar	£29.92
B/V2266-20	1 1/4" BSPP	5 bar	£49.37
B/V2266-24	1 1/2" BSPP	5 bar	£77.17
B/V2266-32	2" BSPP	5 bar	£108.20

PART NUMBER	THREAD	THREAD	PRESSURE	PRICE
B/V2267-04	1/4" BSPT	1/4" BSPP	5 bar	£10.63
B/V2267-06	3/8" BSPT	3/8" BSPP	5 bar	£11.48
B/V2267-08	1/2" BSPT	1/2" BSPP	5 bar	£15.52
B/V2267-12	3/4" BSPT	3/4" BSPP	5 bar	£20.87
B/V2267-16	1" BSPT	1" BSPP	5 bar	£31.41
B/V2267-20	1 1/4" BSPT	1 1/4" BSPP	5 bar	£52.05
B/V2267-24	1 1/2" BSPT	1 1/2" BSPP	5 bar	£79.24
B/V2267-32	2" BSPT	2" BSPP	5 bar	£110.74



FULL FLOW GAS BALL VALVES – BERLIN®

SPECIFICATIONS

Temperature range	-20°C to +60°C (-4°F to +140°F)
-------------------	---------------------------------

MATERIALS

Body	Nickel plated brass
2070, 2071 lever handle	Steel
2072, 2073 T handle	Aluminium

BERLIN® FULL FLOW BSPP FEMALE – ISO7/1



2200

BERLIN® FULL FLOW BSPP MALE / BSPP FEMALE – ISO7/1



2200

PART NUMBER	THREAD	PRESSURE	PRICE
B/V2070-08	1/2" BSPP	5 bar	£17.36
B/V2070-12	3/4" BSPP	5 bar	£26.66
B/V2070-16	1" BSPP	5 bar	£38.55
B/V2070-20	1 1/4" BSPP	5 bar	£58.35
B/V2070-24	1 1/2" BSPP	5 bar	£84.17
B/V2070-32	2" BSPP	5 bar	£122.97

PART NUMBER	THREAD	THREAD	PRESSURE	PRICE
B/V2071-08	1/2" BSPT	1/2" BSPP	5 bar	£17.69
B/V2071-12	3/4" BSPT	3/4" BSPP	5 bar	£26.43
B/V2071-16	1" BSPT	1" BSPP	5 bar	£38.01
B/V2071-20	1 1/4" BSPT	1 1/4" BSPP	5 bar	£57.82
B/V2071-24	1 1/2" BSPT	1 1/2" BSPP	5 bar	£83.55
B/V2071-32	2" BSPT	2" BSPP	5 bar	£120.62

BERLIN® FULL FLOW T HANDLE BSPP FEMALE – ISO7/1



2200

BERLIN® FULL FLOW T HANDLE BSPP MALE / BSPP FEMALE – ISO7/1



2200

PART NUMBER	THREAD	PRESSURE	PRICE
B/V2072-08	1/2" BSPP	5 bar	£17.15
B/V2072-12	3/4" BSPP	5 bar	£26.28
B/V2072-16	1" BSPP	5 bar	£37.90

PART NUMBER	THREAD	THREAD	PRESSURE	PRICE
B/V2073-08	1/2" BSPT	1/2" BSPP	5 bar	£17.94
B/V2073-12	3/4" BSPT	3/4" BSPP	5 bar	£26.05
B/V2073-16	1" BSPT	1" BSPP	5 bar	£37.35

DESCRIPTION

Suitable for domestic water services, heating & air conditioning plants, compressed air systems. Can be installed in any position: vertical, horizontal, oblique.

SPECIFICATIONS

Temperature range	-20°C to +100°C (-4°F to +212°F)		
MATERIALS	EUROPA®	YORK®	BLOCK®
Body	Brass	Brass	Brass
Plate	Stainless steel	Nylon	Polymer
Seal	NBR	NBR	NBR
Spring		Stainless steel	

EUROPA® CHECK VALVE BSPP FEMALE



2200

PART NUMBER	THREAD	PRESSURE	PRICE
B/V3100-06	3/8" BSPP	25 bar	£13.73
B/V3100-08	1/2" BSPP	25 bar	£14.16
B/V3100-12	3/4" BSPP	25 bar	£19.02
B/V3100-16	1" BSPP	25 bar	£26.06
B/V3100-20	1 1/4" BSPP	18 bar	£40.86
B/V3100-24	1 1/2" BSPP	18 bar	£55.44
B/V3100-32	2" BSPP	18 bar	£84.64
B/V3100-40	2 1/2" BSPP	12 bar	£195.79
B/V3100-48	3" BSPP	12 bar	£290.48
B/V3100-64	4" BSPP	12 bar	£486.29

EUROPA® FOOT VALVE BSPP FEMALE



2200

PART NUMBER	THREAD	PRESSURE	PRICE
B/V3105-06	3/8" BSPP	25 bar	£16.04
B/V3105-08	1/2" BSPP	25 bar	£16.77
B/V3105-12	3/4" BSPP	25 bar	£22.04
B/V3105-16	1" BSPP	25 bar	£29.18
B/V3105-20	1 1/4" BSPP	18 bar	£44.78
B/V3105-24	1 1/2" BSPP	18 bar	£59.94
B/V3105-32	2" BSPP	18 bar	£90.84
B/V3105-40	2 1/2" BSPP	12 bar	£214.27
B/V3105-48	3" BSPP	12 bar	£308.42
B/V3105-64	4" BSPP	12 bar	£500.10

YORK® CHECK VALVE BSPP FEMALE



2200

PART NUMBER	THREAD	PRESSURE	PRICE
B/V3103-06	3/8" BSPP	12 bar	£9.70
B/V3103-08	1/2" BSPP	12 bar	£9.89
B/V3103-12	3/4" BSPP	12 bar	£13.33
B/V3103-16	1" BSPP	12 bar	£17.10
B/V3103-20	1 1/4" BSPP	10 bar	£25.44
B/V3103-24	1 1/2" BSPP	10 bar	£37.64
B/V3103-32	2" BSPP	10 bar	£52.56
B/V3103-40	2 1/2" BSPP	8 bar	£100.04
B/V3103-48	3" BSPP	8 bar	£140.99
B/V3103-64	4" BSPP	8 bar	£234.81

YORK® FOOT VALVE BSPP FEMALE



2200

PART NUMBER	THREAD	PRESSURE	PRICE
B/V3108-06	3/8" BSPP	12 bar	£8.30
B/V3108-08	1/2" BSPP	12 bar	£8.27
B/V3108-12	3/4" BSPP	12 bar	£10.55
B/V3108-16	1" BSPP	12 bar	£13.08
B/V3108-20	1 1/4" BSPP	10 bar	£18.86
B/V3108-24	1 1/2" BSPP	10 bar	£27.54
B/V3108-32	2" BSPP	10 bar	£39.64
B/V3108-40	2 1/2" BSPP	6 bar	£75.78
B/V3108-48	3" BSPP	6 bar	£102.94
B/V3108-64	4" BSPP	6 bar	£175.78

BLOCK® CHECK VALVE BSPP FEMALE



2200

PART NUMBER	THREAD	PRESSURE	PRICE
B/V3101-08	1/2" BSPP	12 bar	£6.26
B/V3101-12	3/4" BSPP	12 bar	£8.58
B/V3101-16	1" BSPP	12 bar	£11.19
B/V3101-20	1 1/4" BSPP	10 bar	£16.25
B/V3101-24	1 1/2" BSPP	10 bar	£22.00
B/V3101-32	2" BSPP	10 bar	£30.26

BLOCK® FOOT VALVE BSPP FEMALE



2200

PART NUMBER	THREAD	PRESSURE	PRICE
B/V3106-08	1/2" BSPP	12 bar	£7.01
B/V3106-12	3/4" BSPP	12 bar	£9.37
B/V3106-16	1" BSPP	12 bar	£12.07
B/V3106-20	1 1/4" BSPP	10 bar	£17.55
B/V3106-24	1 1/2" BSPP	10 bar	£23.82
B/V3106-32	2" BSPP	10 bar	£32.80

CHECK VALVES

DESCRIPTION

Suitable for domestic water services, heating & air conditioning plants, & compressed air systems. Can be installed in any position: vertical, horizontal, oblique. Suitable for use with gasoline & fuels in general.

SPECIFICATIONS

Temperature range	-20°C to +100°C (-4°F to +212°F) with water -20°C to +150°C (-4°F to +302°F) with fluid hydrocarbons or compressed air
-------------------	---------------------------------------------------------------------------------------------------------------------------

MATERIALS

Body	Brass
Plate	Stainless steel
Seal	FKM
Spring	Stainless steel



2200

ROMA® CHECK VALVE BSPP FEMALE – ISO 228/1

PART NUMBER	THREAD	PRESSURE	PRICE
B/V3104-06	3/8" BSPP	25 bar	£19.98
B/V3104-08	1/2" BSPP	25 bar	£21.10
B/V3104-12	3/4" BSPP	25 bar	£26.19
B/V3104-16	1" BSPP	25 bar	£35.57
B/V3104-20	1 1/4" BSPP	18 bar	£49.64
B/V3104-24	1 1/2" BSPP	18 bar	£67.68
B/V3104-32	2" BSPP	18 bar	£100.61

STRAINERS FOR USE WITH EUROPA®, YORK®, BLOCK®, ROMA®, CHECK VALVES

STAINLESS STEEL NYLON THREAD BSPP MALE



2200

PART NUMBER	THREAD	MICRON	PRICE
B/V3102-06	3/8" BSPP	1200 µm	£1.73
B/V3102-08	1/2" BSPP	1200 µm	£1.86
B/V3102-12	3/4" BSPP	1200 µm	£2.13
B/V3102-16	1" BSPP	1200 µm	£2.66
B/V3102-20	1 1/4" BSPP	1200 µm	£3.29
B/V3102-24	1 1/2" BSPP	1200 µm	£4.31
B/V3102-32	2" BSPP	1200 µm	£5.56
B/V3102-40	2 1/2" BSPP	2000 µm	£9.47
B/V3102-48	3" BSPP	2000 µm	£11.53
B/V3102-64	4" BSPP	2000 µm	£15.71

POLYMER BSPP MALE



2200

PART NUMBER	THREAD	PRICE
B/V3107-06	3/8" BSPP	£0.86
B/V3107-08	1/2" BSPP	£0.95
B/V3107-12	3/4" BSPP	£1.07
B/V3107-16	1" BSPP	£1.23
B/V3107-20	1 1/4" BSPP	£1.87
B/V3107-24	1 1/2" BSPP	£2.74
B/V3107-32	2" BSPP	£4.04

SWING CHECK & FOOT VALVES

DESCRIPTION

Suitable for domestic water services, heating & air conditioning plants, compressed air systems. They can be installed vertically.

SPECIFICATIONS

Temperature range	0°C to 90°C (32°F to 194°F) with water
-------------------	----------------------------------------

MATERIALS

Body & plate	Brass
Seals	NBR
Foot valve strainer washer	Fibre
Cracking pressure	0.1 psi



2200

FOOT VALVE BSPP FEMALE

PART NUMBER	THREAD	PRESSURE	PRICE
B/V3140-08	1/2" BSPP	10 bar	£13.86
B/V3140-12	3/4" BSPP	10 bar	£15.62
B/V3140-16	1" BSPP	10 bar	£18.66
B/V3140-20	1 1/4" BSPP	8 bar	£26.76
B/V3140-24	1 1/2" BSPP	8 bar	£36.08
B/V3140-32	2" BSPP	8 bar	£52.25
B/V3140-40	2 1/2" BSPP	6 bar	£91.72
B/V3140-48	3" BSPP	6 bar	£125.59
B/V3140-64	4" BSPP	6 bar	£214.07

SWING CHECK VALVE METAL SEAT BSPP FEMALE



2200

PART NUMBER	THREAD	PRESSURE	PRICE
B/V3130-06	3/8" BSPP	16 bar	£13.91
B/V3130-08	1/2" BSPP	16 bar	£12.91
B/V3130-12	3/4" BSPP	16 bar	£17.91
B/V3130-16	1" BSPP	12 bar	£26.26
B/V3130-20	1 1/4" BSPP	10 bar	£39.02
B/V3130-24	1 1/2" BSPP	10 bar	£51.19
B/V3130-32	2" BSPP	10 bar	£72.40
B/V3130-40	2 1/2" BSPP	8 bar	£149.19
B/V3130-48	3" BSPP	8 bar	£206.08
B/V3130-64	4" BSPP	8 bar	£369.16

Y STRAINERS

DESCRIPTION

Suitable for domestic water services, heating & air conditioning plants & compressed air systems.

SPECIFICATIONS

Temperature range -20°C to +110°C (-4°F to +230°F)
in absence of steam

MATERIALS

Body 192 SERIES Brass 193 SERIES Nickel plated brass

200 µm filtration available in sizes 1/4" to 2"
Please ask your distributor for further details



2200

192 SERIES – BSPP FEMALE 500 MICRON FILTRATION

PART NUMBER	THREAD	PRESSURE	PRICE
B/V2192-04	1/4" BSPP	20 bar	£8.82
B/V2192-06	3/8" BSPP	20 bar	£8.82
B/V2192-08	1/2" BSPP	20 bar	£9.04
B/V2192-12	3/4" BSPP	20 bar	£14.76
B/V2192-16	1" BSPP	20 bar	£22.95
B/V2192-20	1 1/4" BSPP	20 bar	£35.07
B/V2192-24	1 1/2" BSPP	20 bar	£46.53
B/V2192-32	2" BSPP	20 bar	£79.21

800 MICRON FILTRATION

B/V2192-40	2 1/2" BSPP	16 bar	£148.93
B/V2192-48	3" BSPP	16 bar	£212.91
B/V2192-64	4" BSPP	16 bar	£413.43



2200

193 SERIES – BSPP FEMALE 500 MICRON FILTRATION

PART NUMBER	THREAD	PRESSURE	PRICE
B/V219350-04	1/4" BSPP	20 bar	£11.31
B/V219350-06	3/8" BSPP	20 bar	£11.32
B/V219350-08	1/2" BSPP	20 bar	£12.03
B/V219350-12	3/4" BSPP	20 bar	£18.75
B/V219350-16	1" BSPP	20 bar	£29.04
B/V219350-20	1 1/4" BSPP	20 bar	£42.30
B/V219350-24	1 1/2" BSPP	20 bar	£55.89
B/V219350-32	2" BSPP	20 bar	£93.77

300 MICRON FILTRATION

B/V219330-04	1/4" BSPP	20 bar	£11.60
B/V219330-06	3/8" BSPP	20 bar	£11.60
B/V219330-08	1/2" BSPP	20 bar	£12.32
B/V219330-12	3/4" BSPP	20 bar	£19.08
B/V219330-16	1" BSPP	20 bar	£29.48
B/V219330-20	1 1/4" BSPP	20 bar	£42.81
B/V219330-24	1 1/2" BSPP	20 bar	£56.50
B/V219330-32	2" BSPP	20 bar	£94.68

50 MICRON FILTRATION

B/V219305-04	1/4" BSPP	20 bar	£12.81
B/V219305-06	3/8" BSPP	20 bar	£12.82
B/V219305-08	1/2" BSPP	20 bar	£13.53
B/V219305-12	3/4" BSPP	20 bar	£20.52
B/V219305-16	1" BSPP	20 bar	£30.90
B/V219305-20	1 1/4" BSPP	20 bar	£44.62
B/V219305-24	1 1/2" BSPP	20 bar	£58.65
B/V219305-32	2" BSPP	20 bar	£97.00

PRESSURE REDUCING VALVES

DESCRIPTION

Suitable for domestic water services, heating & air conditioning plants & compressed air systems.

SPECIFICATIONS

Temperature range 0°C to 80°C
Max. inlet pressure 25 bar
Outlet pressure 1/2", 3/4", 1" = 1 to 5.5 bar
1 1/4" – 2" = 1 to 6 bar



* 1/2", 3/4" & 1" sizes are WRAS approved to 16 bar



2200

PRESSURE REDUCING VALVES ANTIDEZINCIFICATION BRASS BSPP FEMALE – ISO228

PART NUMBER	THREAD	PRESSURE	PRICE
B/V4243-08*	1/2" BSPP	25 bar	£69.47
B/V4243-12*	3/4" BSPP	25 bar	£77.35
B/V4243-16*	1" BSPP	25 bar	£111.06
B/V4243-20	1 1/4" BSPP	25 bar	£209.90
B/V4243-24	1 1/2" BSPP	25 bar	£234.04
B/V4243-32	2" BSPP	25 bar	£352.76



2200

New

PRESSURE REDUCING VALVES NICKEL PLATED BRASS BSPP FEMALE – ISO228

PART NUMBER	THREAD	PRESSURE	PRICE
B/V1430-08	1/2" BSPP	25 bar	£54.34
B/V1430-12	3/4" BSPP	25 bar	£59.85
B/V1430-16	1" BSPP	25 bar	£85.49
B/V1430-20	1 1/4" BSPP	25 bar	£188.68
B/V1430-24	1 1/2" BSPP	25 bar	£211.16
B/V1430-32	2" BSPP	25 bar	£319.81
B/V1430-40	2 1/2" BSPP	25 bar	£556.77
B/V1430-48	3" BSPP	25 bar	£793.90
B/V1430-64	4" BSPP	25 bar	£1770.17

CARTRIDGES



2200

192 / 193 SERIES 500 MICRON FILTRATION

PART NUMBER	FOR STRAINERS	PRICE
B/V2192CA-04	1/4", 3/8", 1/2"	£0.45
B/V2192CA-12	3/4"	£0.63
B/V2192CA-16	1"	£0.80
B/V2192CA-20	1 1/4"	£1.13
B/V2192CA-24	1 1/2"	£1.38
B/V2192CA-32	2"	£1.88

800 MICRON FILTRATION

B/V2192CA-40	2 1/2"	£4.23
B/V2192CA-48	3"	£5.07
B/V2192CA-64	4"	£8.80

BRASS BALL VALVES – EXHAUSTING WITH LOCKING HANDLE

DESCRIPTION

For use as an on-off valve for pneumatic systems. In the off position, downstream air is exhausted to atmosphere through a small vent hole in the valve body. In this way, the danger of pressurised air remaining in the system after shut-off can be eliminated.

SPECIFICATIONS

Temperature range	-10°C to +100°C (14°F to 212°F)
Operating pressure	PN 10

MATERIALS

Body	Nickel plated brass
Ball	Brass, hard chrome
Seals	PTFE
Handle	Steel zinc plated, red plastic coated



**EXHAUSTING
BSPP FEMALE
EN10266-1RP**

2550

PART NUMBER	THREAD	PRESSURE	PRICE
ZBV5110-02	1/4" BSPP	10 bar	£29.55
ZBV5110-03	3/8" BSPP	10 bar	£29.55
ZBV5110-04	1/2" BSPP	10 bar	£30.72
ZBV5110-05	3/4" BSPP	10 bar	£42.00
ZBV5110-06	1" BSPP	10 bar	£65.42

PRESSURE REDUCING VALVES

DESCRIPTION

Pressure reducing & regulating valve with balanced seat. With a brass body, an NBR diaphragm & brass, POM & NBR trim. Complete with a stainless steel 500 micron filter (for upstream flow filtering). With a 1/4" BSP pressure gauge port. Suitable for a maximum inlet pressure of 30 bar g & with a reduced pressure range from 1.5 to 6 bar g. End connections screwed BSP female.

SPECIFICATIONS

Temperature range	-10°C to +70°C (14°F to 158°F)
Operating pressure	Max. 6 bar (87 psi)
Max. inlet pressure	30 bar
Filtration	500 micron

MATERIALS

Body & sleeve	Brass
Seals	NBR / EPDM



**PRESSURE REDUCING VALVE
BSPT MALE UNION**

2555

PART NUMBER	THREAD	PRICE
ZBV30000004	1/2" BSPT	£149.48
ZBV30000005	3/4" BSPT	£175.71
ZBV30000006	1" BSPT	£284.07
ZBV30000007	1 1/4" BSPT	£431.65

SAFETY LOCKOUT VALVES



FEATURES

- Supplied in safety yellow & red (on the same unit)
- Locks in closed-exhaust position only (an OSHA requirement)
- Operating sleeve resists accidental shut-off, yet slides smoothly without sticking after long periods between operations
- Sleeve rotates for location of a standard padlock
- 50% to 60% less costly than other valve types
- Takes less space than spool, poppet & ball valves
- No handles to remove or vibrate off the valve
- Controlled exhaust rate muffles exhaust noise
- Operating sleeve cannot be removed while valve is locked

SPECIFICATIONS

Temperature range	4°C to 52°C (40°F to 125°F)
Working pressure	0.07 bar to 17.2 bar (1 to 250 psi)

MATERIALS

Valve body	Hard anodised Teflon™ coated aluminium
Valve sleeve	Yellow anodised aluminium
Lock-out ring	Red, glass filled nylon
Seals	Pre-lubricated, floating, NBR, O-rings
Media	Compressed air only
Padlocks	Any locking device (key or combination) with a shackle diameter not greater than 3/8"

MEETS OSHA REGULATIONS

In compliance with OSHA standards, the V-35 only locks in the closed / exhaust position. It provides positive lock-out with any shackle diameter up to 3/8".



**GUARDSMAN SERIES
V-35 SAFETY LOCK-OUT**



3210

PART NUMBER	PORT SIZE	CV AVERAGE	PRICE
M-V35-2W	1/4" BSPP	2.44	£72.57
M-V35-3W	3/8" BSPP	4.59	£72.57
M-V35-4W	1/2" BSPP	5.93	£72.57
M-V35-6W	3/4" BSPP	7.29	£72.57



Did you know?

Products with safety benefits are indicated by a chevron at the bottom of their table

PNEUMATICALLY ACTUATED BRASS BALL VALVES

DESCRIPTION

Full bore, brass ISO direct mount ball valves. Available as double & single acting valves. Not suitable for use with solvents.

SPECIFICATIONS

Temperature range	-20°C to +160°C (-4°F to +320°F)
Operating conditions	Fluid water at +20°C, actuator air supply 6 – 7 bar

MATERIALS

Body	Nickel plated brass
Ball	Chrome plated brass
Seals	PTFE with FKM & EPDM O-rings

TWO-WAY BALL VALVE

BSPP FEMALE
DOUBLE ACTING



2555

PART NUMBER	THREAD	PRESSURE	PRICE
ZBV8P0079-02	1/4" BSPP	PN 40	£167.74
ZBV8P0079-03	3/8" BSPP	PN 40	£167.74
ZBV8P0079-04	1/2" BSPP	PN 40	£167.74
ZBV8P0079-05	3/4" BSPP	PN 40	£173.36
ZBV8P0079-06	1" BSPP	PN 40	£198.97
ZBV8P0079-07	1 1/4" BSPP	PN 40	£227.35
ZBV8P0079-08	1 1/2" BSPP	PN 40	£319.84
ZBV8P0079-10	2" BSPP	PN 40	£397.88

TWO-WAY BALL VALVE

BSPP FEMALE
SINGLE ACTING



2555

PART NUMBER	THREAD	PRESSURE	PRICE
ZBV8P0081-02	1/4" BSPP	PN 40	£230.69
ZBV8P0081-03	3/8" BSPP	PN 40	£230.69
ZBV8P0081-04	1/2" BSPP	PN 40	£230.69
ZBV8P0081-05	3/4" BSPP	PN 40	£236.31
ZBV8P0081-06	1" BSPP	PN 40	£261.91
ZBV8P0081-07	1 1/4" BSPP	PN 40	£290.28
ZBV8P0081-08	1 1/2" BSPP	PN 40	£369.63
ZBV8P0081-10	2" BSPP	PN 40	£447.68

THREE-WAY BALL VALVE – T PORT

BSPP FEMALE
DOUBLE ACTING



2555

PART NUMBER	THREAD	PRESSURE	PRICE
ZBV8P0083-02	1/4" BSPP	PN 30	£196.10
ZBV8P0083-03	3/8" BSPP	PN 30	£196.10
ZBV8P0083-04	1/2" BSPP	PN 30	£203.06
ZBV8P0083-05	3/4" BSPP	PN 30	£276.98
ZBV8P0083-06	1" BSPP	PN 16	£343.13
ZBV8P0083-07	1 1/4" BSPP	PN 10	£436.09
ZBV8P0083-08	1 1/2" BSPP	PN 10	£606.52
ZBV8P0083-10	2" BSPP	PN 10	£960.80

THREE-WAY BALL VALVE – L PORT

BSPP FEMALE
DOUBLE ACTING



2555

PART NUMBER	THREAD	PRESSURE	PRICE
ZBV8P0084-02	1/4" BSPP	PN 30	£196.10
ZBV8P0084-03	3/8" BSPP	PN 30	£196.10
ZBV8P0084-04	1/2" BSPP	PN 30	£203.06
ZBV8P0084-05	3/4" BSPP	PN 30	£276.98
ZBV8P0084-06	1" BSPP	PN 16	£343.13
ZBV8P0084-07	1 1/4" BSPP	PN 10	£435.66
ZBV8P0084-08	1 1/2" BSPP	PN 10	£606.52
ZBV8P0084-10	2" BSPP	PN 10	£960.80

SINGLE ACTING

PART NUMBER	THREAD	PRESSURE	PRICE
ZBV8P0085-02	1/4" BSPP	PN 30	£257.23
ZBV8P0085-03	3/8" BSPP	PN 30	£257.23
ZBV8P0085-04	1/2" BSPP	PN 30	£264.19
ZBV8P0085-05	3/4" BSPP	PN 30	£325.32
ZBV8P0085-06	1" BSPP	PN 16	£391.49
ZBV8P0085-07	1 1/4" BSPP	PN 10	£484.03
ZBV8P0085-08	1 1/2" BSPP	PN 10	£748.07
ZBV8P0085-10	2" BSPP	PN 10	£1141.17

SINGLE ACTING

PART NUMBER	THREAD	PRESSURE	PRICE
ZBV8P0086-02	1/4" BSPP	PN 30	£257.23
ZBV8P0086-03	3/8" BSPP	PN 30	£257.23
ZBV8P0086-04	1/2" BSPP	PN 30	£264.19
ZBV8P0086-05	3/4" BSPP	PN 30	£325.32
ZBV8P0086-06	1" BSPP	PN 16	£391.49
ZBV8P0086-07	1 1/4" BSPP	PN 10	£484.03
ZBV8P0086-08	1 1/2" BSPP	PN 10	£748.07
ZBV8P0086-10	2" BSPP	PN 10	£1141.17

FEATURES

- This product switches compressed air on / off on air pressure devices by simply turning the handle
- Maintenance or inspection is possible when the remaining pressure in the device is removed
- A three-way valve discharges the remaining pressure out, & blocks the incoming air in the off state
- Four types available depending on the method applied to air pressure flow

APPLICATIONS

- Used for switching compressed air

SPECIFICATIONS

Suitability	Air (no other type of gas or liquid) Do not use in water applications
Working pressure	0 to 10.2 bar (0 to 150 psi)
Negative pressure	-29.5 in Hg / -750 mm Hg (-750 Torr)
Working temperature	0°C to +60°C (+32°F to +140°F)
Application tube	Polyurethane & nylon

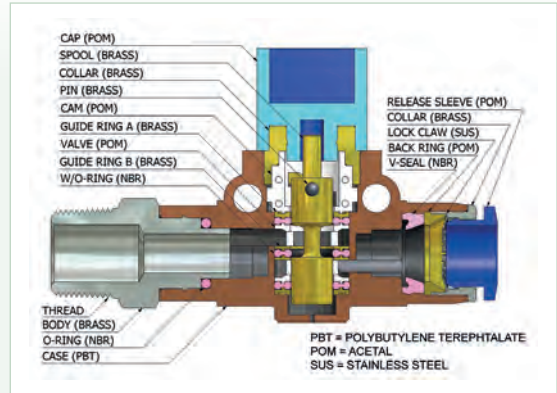

TUBE TO THREAD



**STRAIGHT A VALVE
BSPT MALE**

3700

PART NUMBER	TUBE OD	THREAD	PRICE each
CDHVC0401	4 mm	1/8" BSPT	£11.40
CDHVC0402	4 mm	1/4" BSPT	£11.84
CDHVC0403	4 mm	3/8" BSPT	£12.27
CDHVC0601	6 mm	1/8" BSPT	£11.41
CDHVC0602	6 mm	1/4" BSPT	£11.84
CDHVC0603	6 mm	3/8" BSPT	£12.28
CDHVC0801	8 mm	1/8" BSPT	£12.28
CDHVC0802	8 mm	1/4" BSPT	£12.72
CDHVC0803	8 mm	3/8" BSPT	£13.17
CDHVC1002	10 mm	1/4" BSPT	£13.17
CDHVC1003	10 mm	3/8" BSPT	£13.60
CDHVC1004	10 mm	1/2" BSPT	£14.13
CDHVC1202	12 mm	1/4" BSPT	£14.13
CDHVC1203	12 mm	3/8" BSPT	£14.48
CDHVC1204	12 mm	1/2" BSPT	£14.92



**STRAIGHT A VALVE
BSPP MALE**

3700

PART NUMBER	TUBE OD	THREAD	PRICE each
CDHVC04G01	4 mm	1/8" BSPP	£11.40
CDHVC04G02	4 mm	1/4" BSPP	£11.84
CDHVC04G03	4 mm	3/8" BSPP	£12.27
CDHVC06G01	6 mm	1/8" BSPP	£11.41
CDHVC06G02	6 mm	1/4" BSPP	£11.84
CDHVC06G03	6 mm	3/8" BSPP	£12.28
CDHVC08G01	8 mm	1/8" BSPP	£12.28
CDHVC08G02	8 mm	1/4" BSPP	£12.72
CDHVC08G03	8 mm	3/8" BSPP	£13.17
CDHVC10G02	10 mm	1/4" BSPP	£13.17
CDHVC10G03	10 mm	3/8" BSPP	£13.60
CDHVC10G04	10 mm	1/2" BSPP	£14.13
CDHVC12G02	12 mm	1/4" BSPP	£14.13
CDHVC12G03	12 mm	3/8" BSPP	£14.48
CDHVC12G04	12 mm	1/2" BSPP	£14.92



**STRAIGHT B VALVE
BSPT MALE**

3700

PART NUMBER	THREAD	TUBE OD	PRICE each
CDHVF0104	1/8" BSPT	4 mm	£11.40
CDHVF0204	1/4" BSPT	4 mm	£12.28
CDHVF0304	3/8" BSPT	4 mm	£13.17
CDHVF0106	1/8" BSPT	6 mm	£11.41
CDHVF0206	1/4" BSPT	6 mm	£12.28
CDHVF0306	3/8" BSPT	6 mm	£13.17
CDHVF0108	1/8" BSPT	8 mm	£11.84
CDHVF0208	1/4" BSPT	8 mm	£12.28
CDHVF0308	3/8" BSPT	8 mm	£13.60
CDHVF0210	1/4" BSPT	10 mm	£12.72
CDHVF0310	3/8" BSPT	10 mm	£14.13
CDHVF0410	1/2" BSPT	10 mm	£14.48
CDHVF0212	1/4" BSPT	12 mm	£13.17
CDHVF0312	3/8" BSPT	12 mm	£14.13
CDHVF0412	1/2" BSPT	12 mm	£14.92



**STRAIGHT B VALVE
BSPP MALE**

3700

PART NUMBER	THREAD	TUBE OD	PRICE each
CDHVFG0104	1/8" BSPP	4 mm	£11.41
CDHVFG0204	1/4" BSPP	4 mm	£12.28
CDHVFG0304	3/8" BSPP	4 mm	£13.17
CDHVFG0106	1/8" BSPP	6 mm	£11.41
CDHVFG0206	1/4" BSPP	6 mm	£12.28
CDHVFG0306	3/8" BSPP	6 mm	£13.17
CDHVFG0108	1/8" BSPP	8 mm	£11.84
CDHVFG0208	1/4" BSPP	8 mm	£12.28
CDHVFG0308	3/8" BSPP	8 mm	£13.60
CDHVFG0210	1/4" BSPP	10 mm	£12.72
CDHVFG0310	3/8" BSPP	10 mm	£14.13
CDHVFG0410	1/2" BSPP	10 mm	£14.48
CDHVFG0212	1/4" BSPP	12 mm	£13.17
CDHVFG0312	3/8" BSPP	12 mm	£14.13
CDHVFG0412	1/2" BSPP	12 mm	£14.92

BALL VALVES

To insert the tube into the fitting, insert it fully to the end, & to release, shut off the compressed air & push the sleeve gently to pull the tube out.

Be sure to select the product according to your needs, as hand valves vent the downstream line using a three-way method, so leakage may occur when fluids other than air are applied.

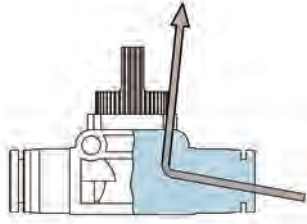

METRIC TUBE TO TUBE

STRAIGHT UNION VALVE EXHAUSTING SOLD IN PACKS OF 10

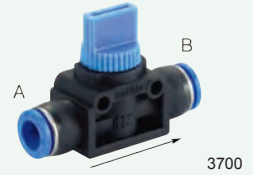

PART NUMBER	TUBE OD A	TUBE OD B	PRICE each
CDHVU0404	4 mm	4 mm	£10.53
CDHVU0606	6 mm	6 mm	£10.54
CDHVU0806	8 mm	6 mm	£11.41
CDHVU0808	8 mm	8 mm	£11.41
CDHVU1008	10 mm	8 mm	£12.28
CDHVU1010	10 mm	10 mm	£12.28
CDHVU1210	12 mm	10 mm	£13.17
CDHVU1212	12 mm	12 mm	£13.17

BSPT THREAD

HAND VALVE VALVE EXHAUSTING BSPT MALE SOLD IN PACKS OF 10



PART NUMBER	THREAD A	THREAD B	PRICE each
CDHVM0101	1/8" BSPT	1/8" BSPT	£12.28
CDHVM0201	1/4" BSPT	1/8" BSPT	£13.17
CDHVM0202	1/4" BSPT	1/4" BSPT	£14.13
CDHVM0302	3/8" BSPT	1/4" BSPT	£14.92
CDHVM0303	3/8" BSPT	3/8" BSPT	£15.80
CDHVM0403	1/2" BSPT	3/8" BSPT	£16.68
CDHVM0404	1/2" BSPT	1/2" BSPT	£17.55

BSPP THREAD

HAND VALVE VALVE EXHAUSTING BSPP MALE SOLD IN PACKS OF 10

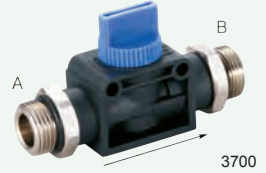

PART NUMBER	THREAD A	THREAD B	PRICE each
CDHVMG0101	1/8" BSPP	1/8" BSPP	£12.28
CDHVMG0201	1/4" BSPP	1/8" BSPP	£13.17
CDHVMG0202	1/4" BSPP	1/4" BSPP	£14.13
CDHVMG0302	3/8" BSPP	1/4" BSPP	£14.92
CDHVMG0303	3/8" BSPP	3/8" BSPP	£15.80
CDHVMG0403	1/2" BSPP	3/8" BSPP	£16.68
CDHVMG0404	1/2" BSPP	1/2" BSPP	£17.55

SLIDE VALVES

HAND SLIDE VALVE METRIC MALE SOLD IN PACKS OF 10



PART NUMBER	THREAD	PRICE each
CDHSVM-M5	M5 x 0.8	£10.99

BSPT MALE

PART NUMBER	THREAD	PRICE each
CDHSVM-01	1/8" BSPT	£14.04
CDHSVM-02	1/4" BSPT	£24.00
CDHSVM-03	3/8" BSPT	£42.85
CDHSVM-04	1/2" BSPT	£46.16
CDHSVM-06	3/4" BSPT	£58.81

uPVC SPECIFICATIONS		
Pressure rating @ 20 °C	Thread 3/8" – 2"	Thread 2 1/2" – 4"
	16 bar	10 bar
Temperature range	0°C to 60°C increase in temperature will reduce working pressure	

ABS SPECIFICATIONS		
Pressure rating @ 20°C	Thread 3/8" – 2"	Thread 2 1/2" & 4"
	15 bar	9 bar
Temperature range	-40°C to +80°C increase in temperature will reduce working pressure	



**SINGLE UNION – uPVC
EPDM SEALS – FEMALE THREAD**

**SINGLE UNION
FOR SOLVENT WELDING – uPVC
EPDM SEALS**

PART NUMBER	THREAD	PRICE
aPBVS11-38	3/8"	£18.65
aPBVS11-12	1/2"	£18.65
aPBVS11-34	3/4"	£23.63
aPBVS11-1	1"	£28.48
aPBVS11114	1 1/4"	£42.12
aPBVS11112	1 1/2"	£56.16
aPBVS11-2	2"	£88.36
aPBVS11212	2 1/2"	£204.26
aPBVS11-3	3"	£228.41
aPBVS11-4	4"	£372.39

PART NUMBER	TUBE NB	PRICE
aPBVS13-38	3/8"	£16.96
aPBVS13-12	1/2"	£16.96
aPBVS13-34	3/4"	£19.81
aPBVS13-1	1"	£23.27
aPBVS13114	1 1/4"	£37.90
aPBVS13112	1 1/2"	£49.53
aPBVS13-2	2"	£72.38
aPBVS13212	2 1/2"	£194.57
aPBVS13-3	3"	£216.01
aPBVS13-4	4"	£364.11



**DOUBLE UNION – uPVC
EPDM SEALS – FEMALE THREAD**

**DOUBLE UNION
FOR SOLVENT WELDING – uPVC
EPDM SEALS**

PART NUMBER	THREAD	PRICE
aPBVD11-38	3/8"	£28.24
aPBVD11-12	1/2"	£28.24
aPBVD11-34	3/4"	£27.52
aPBVD11-1	1"	£42.62
aPBVD11114	1 1/4"	£57.04
aPBVD11112	1 1/2"	£71.32
aPBVD11-2	2"	£105.76
aPBVD11212	2 1/2"	£321.25
aPBVD11-3	3"	£336.81
aPBVD11-4	4"	£641.65

PART NUMBER	TUBE NB	PRICE
aPBVD13-38	3/8"	£22.85
aPBVD13-12	1/2"	£22.85
aPBVD13-34	3/4"	£28.70
aPBVD13-1	1"	£44.24
aPBVD13114	1 1/4"	£53.03
aPBVD13112	1 1/2"	£65.68
aPBVD13-2	2"	£100.02
aPBVD13212	2 1/2"	£303.06
aPBVD13-3	3"	£320.90
aPBVD13-4	4"	£603.56



**INDUSTRIAL DOUBLE UNION
FOR SOLVENT WELDING – uPVC
EPDM SEALS**

**INDUSTRIAL DOUBLE UNION
FOR SOLVENT WELDING – uPVC
FPM SEALS**

PART NUMBER	TUBE NB	PRICE
aPBVI13-38	3/8"	£73.94
aPBVI13-12	1/2"	£73.94
aPBVI13-34	3/4"	£87.85
aPBVI13-1	1"	£105.56
aPBVI13114	1 1/4"	£133.87
aPBVI13112	1 1/2"	£175.48
aPBVI13-2	2"	£168.03
aPBVI13212	2 1/2"	£463.80
aPBVI13-3	3"	£403.26
aPBVI13-4	4"	£737.10

PART NUMBER	TUBE NB	PRICE
aPBVI33-38	3/8"	£89.61
aPBVI33-12	1/2"	£89.61
aPBVI33-34	3/4"	£105.50
aPBVI33-1	1"	£126.74
aPBVI33114	1 1/4"	£160.55
aPBVI33112	1 1/2"	£209.60
aPBVI33-2	2"	£265.36
aPBVI33212	2 1/2"	£553.66
aPBVI33-3	3"	£658.20
aPBVI33-4	4"	£843.04



**INDUSTRIAL DOUBLE UNION
FOR SOLVENT WELDING – ABS
EPDM SEALS**

**INDUSTRIAL DOUBLE UNION
FOR SOLVENT WELDING – ABS
FPM SEALS**

PART NUMBER	TUBE NB	PRICE
aABVI13-38	3/8"	£69.02
aABVI13-12	1/2"	£71.05
aABVI13-34	3/4"	£84.47
aABVI13-1	1"	£100.82
aABVI13114	1 1/4"	£129.21
aABVI13112	1 1/2"	£166.53
aABVI13-2	2"	£211.86
aABVI13212	2 1/2"	£420.98
aABVI13-3	3"	£540.32
aABVI13-4	4"	£750.81

PART NUMBER	TUBE NB	PRICE
aABVI33-38	3/8"	£83.26
aABVI33-12	1/2"	£86.31
aABVI33-34	3/4"	£100.27
aABVI33-1	1"	£125.75
aABVI33114	1 1/4"	£152.57
aABVI33112	1 1/2"	£201.38
aABVI33-2	2"	£271.94
aABVI33212	2 1/2"	£483.47
aABVI33-3	3"	£669.03
aABVI33-4	4"	£860.74

APPLICATIONS

- Industrial, pneumatic, domestic & hydraulic installations
- Compressed air
- Water
- Oils
- Gas

SPECIFICATIONS

Temperature range -18°C to +80°C (0°F to 176°F)

MATERIALS

Body Chrome nickel plated brass unless otherwise stated



1450



1450

FULL FLOW BSPT FEMALE – ISO7/1

FULL FLOW BSPT MALE / BSPT FEMALE ISO7/1

PART NUMBER	THREAD	PRESSURE	PRICE
B/V6300-02	1/8" BSPT	20 bar	£14.25
B/V6300-04	1/4" BSPT	20 bar	£14.87
B/V6300-06	3/8" BSPT	20 bar	£15.56
B/V6300-08	1/2" BSPT	20 bar	£22.43
B/V6300-12	3/4" BSPT	20 bar	£31.64

PART NUMBER	THREAD	THREAD	PRESSURE	PRICE
B/V6310-02	1/8" BSPT	1/8" BSPT	20 bar	£14.25
B/V6310-03	1/4" BSPT	1/8" BSPT	20 bar	£14.32
B/V6310-04	1/4" BSPT	1/4" BSPT	20 bar	£14.87
B/V6310-06	3/8" BSPT	3/8" BSPT	20 bar	£15.39
B/V6310-08	1/2" BSPT	1/2" BSPT	20 bar	£22.22
B/V6310-12	3/4" BSPT	3/4" BSPT	20 bar	£31.22

New

FULL FLOW FOOT MOUNTED BSPP FEMALE – ISO7/1



1450

PART NUMBER	THREAD	PRESSURE	PRICE
B/V6490-04	1/4" BSPP	20 bar	£21.74
B/V6490-06	3/8" BSPP	20 bar	£28.57

FULL FLOW BSPT MALE THREAD – ISO7/1 BSPP MALE THREAD – ISO228



1450

PART NUMBER	THREAD	THREAD	PRESSURE	PRICE
B/V6330-022	1/8" BSPT	1/8" BSPP	20 bar	£14.18
B/V6330-024	1/8" BSPT	1/4" BSPP	20 bar	£14.18
B/V6330-042	1/4" BSPT	1/8" BSPP	20 bar	£14.25
B/V6330-044	1/4" BSPT	1/4" BSPP	20 bar	£14.11
B/V6330-066	3/8" BSPT	3/8" BSPP	20 bar	£14.97
B/V6330-088	1/2" BSPT	1/2" BSPP	20 bar	£20.98
B/V6330-12	3/4" BSPT	3/4" BSPP	20 bar	£29.29

FULL FLOW BSPP MALE – ISO228 BSPT FEMALE – ISO7/1



1450

PART NUMBER	MALE THREAD	FEMALE THREAD	PRESSURE	PRICE
B/V6320-022	1/8" BSPP	1/8" BSPT	20 bar	£14.25
B/V6320-042	1/4" BSPP	1/8" BSPT	20 bar	£14.25
B/V6320-044	1/4" BSPP	1/4" BSPT	20 bar	£14.70
B/V6320-066	3/8" BSPP	3/8" BSPT	20 bar	£15.35
B/V6320-088	1/2" BSPP	1/2" BSPT	20 bar	£22.08
B/V6320-12	3/4" BSPP	3/4" BSPT	20 bar	£30.88

FULL FLOW BSPP MALE – ISO228 BSPP FEMALE – ISO228



1450

PART NUMBER	THREAD	THREAD	PRESSURE	PRICE
B/V6410-022	1/8" BSPP	1/8" BSPP	20 bar	£14.25
B/V6410-042	1/4" BSPP	1/8" BSPP	20 bar	£14.25
B/V6410-044	1/4" BSPP	1/4" BSPP	20 bar	£14.70
B/V6410-066	3/8" BSPP	3/8" BSPP	20 bar	£15.11
B/V6410-088	1/2" BSPP	1/2" BSPP	20 bar	£22.01
B/V6410-12	3/4" BSPP	3/4" BSPP	20 bar	£30.64

FULL FLOW BSPP FEMALE – ISO228



1450

PART NUMBER	THREAD	PRESSURE	PRICE
B/V6400-02	1/8" BSPP	20 bar	£14.25
B/V6400-04	1/4" BSPP	20 bar	£14.70
B/V6400-06	3/8" BSPP	20 bar	£15.35
B/V6400-08	1/2" BSPP	20 bar	£22.01
B/V6400-12	3/4" BSPP	20 bar	£31.15

FULL FLOW BSPP MALE – ISO228



1450

PART NUMBER	THREAD	THREAD	PRESSURE	PRICE
B/V6420-02	1/8" BSPP	1/8" BSPP	20 bar	£14.15
B/V6420-03	1/8" BSPP	1/4" BSPP	20 bar	£14.15
B/V6420-04	1/4" BSPP	1/4" BSPP	20 bar	£14.15
B/V6420-05	3/8" BSPP	1/4" BSPP	20 bar	£14.15
B/V6420-06	3/8" BSPP	3/8" BSPP	20 bar	£14.84
B/V6420-07	1/2" BSPP	3/8" BSPP	20 bar	£14.97
B/V6420-08	1/2" BSPP	1/2" BSPP	20 bar	£20.67
B/V6420-09	1/2" BSPP	3/4" BSPP	20 bar	£21.91
B/V6420-12	3/4" BSPP	3/4" BSPP	20 bar	£29.39



1450

**FULL FLOW
BSPT FEMALE /
COMPRESSION ISO7/1**

PART NUMBER	THREAD	TUBE OD	PRESSURE	PRICE
B/V6340-026	1/8" BSPT	6 mm	20 bar	£16.15
B/V6340-028	1/8" BSPT	8 mm	20 bar	£16.35
B/V6340-048	1/4" BSPT	8 mm	20 bar	£17.04
B/V6340-061	3/8" BSPT	10 mm	20 bar	£17.87
B/V6340-062	3/8" BSPT	12 mm	20 bar	£18.15
B/V6340-084	1/2" BSPT	14 mm	20 bar	£26.91
B/V6340-085	1/2" BSPT	15 mm	20 bar	£26.91
B/V6340-126	3/4" BSPT	16 mm	20 bar	£38.05
B/V6340-128	3/4" BSPT	18 mm	20 bar	£38.09



1450

**FULL FLOW
BSPP FEMALE /
COMPRESSION ISO228**

PART NUMBER	THREAD	TUBE OD	PRESSURE	PRICE
B/V6430-026	1/8" BSPP	6 mm	20 bar	£16.18
B/V6430-028	1/8" BSPP	8 mm	20 bar	£16.39
B/V6430-048	1/4" BSPP	8 mm	20 bar	£17.04
B/V6430-061	3/8" BSPP	10 mm	20 bar	£17.80
B/V6430-062	3/8" BSPP	12 mm	20 bar	£18.11
B/V6430-084	1/2" BSPP	14 mm	20 bar	£26.53
B/V6430-085	1/2" BSPP	15 mm	20 bar	£26.53
B/V6430-126	3/4" BSPP	16 mm	20 bar	£37.54
B/V6430-128	3/4" BSPP	18 mm	20 bar	£37.54



1450

**FULL FLOW
BSPT MALE /
COMPRESSION ISO7/1**

PART NUMBER	THREAD	TUBE OD	PRESSURE	PRICE
B/V6350-026	1/8" BSPT	6 mm	20 bar	£16.04
B/V6350-028	1/8" BSPT	8 mm	20 bar	£16.35
B/V6350-046	1/4" BSPT	6 mm	20 bar	£16.15
B/V6350-048	1/4" BSPT	8 mm	20 bar	£16.35
B/V6350-061	3/8" BSPT	10 mm	20 bar	£17.42
B/V6350-062	3/8" BSPT	12 mm	20 bar	£17.80
B/V6350-084	1/2" BSPT	14 mm	20 bar	£25.74
B/V6350-085	1/2" BSPT	15 mm	20 bar	£25.74
B/V6350-126	3/4" BSPT	16 mm	20 bar	£36.29
B/V6350-128	3/4" BSPT	18 mm	20 bar	£36.29



1450

**FULL FLOW
COMPRESSION**

PART NUMBER	TUBE OD	PRESSURE	PRICE
B/V6450-6	6 mm	20 bar	£17.97
B/V6450-8	8 mm	20 bar	£18.63
B/V6450-10	10 mm	20 bar	£19.60
B/V6450-12	12 mm	20 bar	£22.18
B/V6450-15	15 mm	20 bar	£29.67



1450

**FULL FLOW
BSPP MALE /
COMPRESSION ISO228**

PART NUMBER	THREAD	TUBE OD	PRESSURE	PRICE
B/V6440-026	1/8" BSPP	6 mm	20 bar	£16.15
B/V6440-028	1/8" BSPP	8 mm	20 bar	£16.35
B/V6440-046	1/4" BSPP	6 mm	20 bar	£15.90
B/V6440-048	1/4" BSPP	8 mm	20 bar	£16.35
B/V6440-041	1/4" BSPP	10 mm	20 bar	£16.59
B/V6440-068	3/8" BSPP	8 mm	20 bar	£16.63
B/V6440-061	3/8" BSPP	10 mm	20 bar	£17.22
B/V6440-062	3/8" BSPP	12 mm	20 bar	£17.42
B/V6440-064	3/8" BSPP	14 mm	20 bar	£19.11
B/V6440-065	3/8" BSPP	15 mm	20 bar	£19.25
B/V6440-081	1/2" BSPP	10 mm	20 bar	£17.42
B/V6440-082	1/2" BSPP	12 mm	20 bar	£18.66
B/V6440-084	1/2" BSPP	14 mm	20 bar	£25.50
B/V6440-085	1/2" BSPP	15 mm	20 bar	£25.50
B/V6440-124	3/4" BSPP	14 mm	20 bar	£27.77
B/V6440-125	3/4" BSPP	15 mm	20 bar	£27.77
B/V6440-126	3/4" BSPP	16 mm	20 bar	£35.85
B/V6440-128	3/4" BSPP	18 mm	20 bar	£35.85



1450

**FULL FLOW FOOT MOUNTED
COMPRESSION**

PART NUMBER	TUBE OD	PRESSURE	PRICE
B/V6500-8	8 mm	20 bar	£25.91



**FULL FLOW – STAINLESS STEEL
BSPT MALE – ISO228
BSPP FEMALE – ISO7/1**



1450

PART NUMBER	MALE THREAD	FEMALE THREAD	PRESSURE	PRICE
B/V6631-02	1/8" BSPT	1/8" BSPP	20 bar	£123.41
B/V6631-04	1/4" BSPT	1/4" BSPP	20 bar	£135.16

BALL VALVES

APPLICATIONS

- Industrial, pneumatic, domestic & hydraulic installations
- Compressed air
- Water
- Oils

SPECIFICATIONS

Temperature range -18°C to +80°C (0°F to 176°F)

MATERIALS

Body Chrome nickel plated brass



FULL FLOW TEE – L PORT
BSPP FEMALE – ISO228

1450

PART NUMBER	THREAD	PRESSURE	PRICE
B/V6700-02	1/8" BSPP	20 bar	£33.40
B/V6700-04	1/4" BSPP	20 bar	£33.95
B/V6700-06	3/8" BSPP	20 bar	£37.29



FULL FLOW TEE – T PORT
BSPP FEMALE – ISO228

1450

PART NUMBER	THREAD	PRESSURE	PRICE
B/V6710-02	1/8" BSPP	20 bar	£33.40
B/V6710-04	1/4" BSPP	20 bar	£33.95
B/V6710-06	3/8" BSPP	20 bar	£37.29



FULL FLOW ELBOW
BSPP FEMALE – ISO228

1450

PART NUMBER	THREAD	PRESSURE	PRICE
B/V6720-02	1/8" BSPP	20 bar	£30.08
B/V6720-04	1/4" BSPP	20 bar	£30.60
B/V6720-06	3/8" BSPP	20 bar	£33.84



FULL FLOW VALVE
PUSH-IN

1450

PART NUMBER	TUBE OD	PRESSURE	PRICE
B/V6560-04	4 mm	20 bar	£21.32
B/V6560-06	6 mm	20 bar	£22.53
B/V6560-08	8 mm	20 bar	£23.67
B/V6560-10	10 mm	20 bar	£24.29
B/V6560-12	12 mm	20 bar	£27.74



FULL FLOW VALVE
BSPT MALE / PUSH-IN

1450

PART NUMBER	THREAD	TUBE OD	PRESSURE	PRICE
B/V6570-024	1/8" BSPT	4 mm	20 bar	£16.46
B/V6570-026	1/8" BSPT	6 mm	20 bar	£16.97
B/V6570-028	1/8" BSPT	8 mm	20 bar	£17.56
B/V6570-046	1/4" BSPT	6 mm	20 bar	£17.32
B/V6570-048	1/4" BSPT	8 mm	20 bar	£17.84



FULL FLOW VALVE EXHAUST HOLE
BSPT FEMALE

1450

PART NUMBER	THREAD	PRESSURE	PRICE
B/V6600-02	1/8" BSPP	20 bar	£20.98
B/V6600-04	1/4" BSPP	20 bar	£21.05
B/V6600-06	3/8" BSPP	20 bar	£22.74

ACCESSORIES

STANDARD HANDLE



1450

PART NUMBER	LENGTH	BALL VALVE SIZE	PRICE
B/V6900-A	19 mm	1/8", 1/4", 3/8"	£0.79
B/V6900-B	26 mm	1/2", 3/4"	£1.10

LONG HANDLE



1450

PART NUMBER	LENGTH	BALL VALVE SIZE	PRICE
B/V6910-A	35 mm	1/8", 1/4", 3/8"	£0.86
B/V6910-B	50 mm	1/2", 3/4"	£1.55



1450

COLOURED PLATE

PART NUMBER	COLOUR	BALL VALVE SIZE	PRICE
B/V6920-AR	Red	1/8", 1/4", 3/8"	£0.28
B/V6920-AB	Blue	1/8", 1/4", 3/8"	£0.28
B/V6920-AY	Yellow	1/8", 1/4", 3/8"	£0.28
B/V6920-AG	Green	1/8", 1/4", 3/8"	£0.28
B/V6920-AW	White	1/8", 1/4", 3/8"	£0.28
B/V6900-BR	Red	1/2", 3/4"	£0.28
B/V6900-BB	Blue	1/2", 3/4"	£0.28
B/V6900-BY	Yellow	1/2", 3/4"	£0.28
B/V6900-BG	Green	1/2", 3/4"	£0.28
B/V6900-BW	White	1/2", 3/4"	£0.28

FEATURES

- On / off service ball valve with 2-way pattern
- Diverter service ball valve with 3-way pattern
- Stainless steel & brass construction
- Variable end connection types & sizes from 1/16" to 3/4" 3 mm to 18 mm
- Operation with coloured nylon handles, metal handle & colour anodised aluminium

GENERAL

High performance instrumentation ball valve for general service & instrumentation panels. The valves offer tight shut-off*, long life service & low operating torque. Performs on / off or diverter service.

*Only straight & angle patterns

TESTING

Tested for Burst & Proof. Standard testing for each valve includes testing with nitrogen at 80 & 1000 psig. Each valve is tested for leakage through the shell, packing & ball seats. The maximum allowable leakage across the ball seats is 0.1 std cc/min.

IMPERIAL



1756



1756

BALL VALVES COMPRESSION

PART NUMBER	TUBE OD	PRESSURE	PRICE
FK-BOSSFL202	1/8"	3000 psi	£153.34
FK-BOSSFL405	1/4"	3000 psi	£191.80
FK-BOSSFL607	3/8"	3000 psi	£294.80
FK-BOSSFL810	1/2"	3000 psi	£398.05

BALL VALVES 3 PORT – COMPRESSION

PART NUMBER	TUBE OD	PRESSURE	PRICE
FK-BVSSFL4053	1/4"	1500 psi	£282.29
FK-BVSSFL6063	3/8"	1500 psi	£356.57
FK-BVSSFL8103	1/2"	1500 psi	£554.45



1756



1756

BALL VALVES 3 PORT – COMPRESSION

PART NUMBER	TUBE OD	PRESSURE	PRICE
FK-BOSSFL2023L	1/8"	3000 psi	£233.96
FK-BOSSFL4053L	1/4"	3000 psi	£304.11
FK-BOSSFL6073L	3/8"	3000 psi	£374.77
FK-BOSSFL8103L	1/2"	3000 psi	£525.90

BALL VALVES 3 PORT – NPT FEMALE

PART NUMBER	THREAD	PRESSURE	PRICE
FK-BVSSFNS4063	1/4" NPT	1500 psi	£287.28
FK-BVSSFNS6103	3/8" NPT	1500 psi	£408.64
FK-BVSSFNS8103	1/2" NPT	1500 psi	£453.84



1756



1756

BALL VALVES COMPRESSION

PART NUMBER	TUBE OD	PRESSURE	PRICE
FK-BVSSFL202	1/8"	1500 psi	£176.62
FK-BVSSFL405	1/4"	1500 psi	£189.81
FK-BVSSFL606	3/8"	1500 psi	£257.48
FK-BVSSFL810	1/2"	1500 psi	£382.75
FK-BVSSFL1210	3/4"	1500 psi	£495.59

BALL VALVES NPT FEMALE

PART NUMBER	THREAD	PRESSURE	PRICE
FK-BVSSFNS204	1/8" NPT	1500 psi	£192.80
FK-BVSSFNS406	1/4" NPT	1500 psi	£221.21
FK-BVSSFNS610	3/8" NPT	1500 psi	£384.86
FK-BVSSFNS810	1/2" NPT	1500 psi	£379.62
FK-BVSSFNS1210	3/4" NPT	1500 psi	£412.56

FEATURES

- On / off service ball valve with 2-way pattern
- Diverter service ball valve with 3-way pattern
- Stainless steel & brass construction
- Variable end connection types & sizes from 1/16" to 3/4" 3 mm to 18 mm
- Operation with coloured nylon handles, metal handle & colour anodised aluminium

GENERAL

High performance instrumentation ball valve for general service & instrumentation panels. The valves offer tight shut-off*, long service life & low operating torque. Performs on / off or diverter service.

*Only straight & angle patterns

TESTING

Tested for Burst & Proof. Standard testing for each valve includes testing with nitrogen at 80 & 1000 psig. Each valve is tested for leakage through the shell, packing & ball seats. The maximum allowable leakage across the ball seats is 0.1 std cc/min.

METRIC COMPRESSION BALL VALVES



1756

BALL VALVES COMPRESSION

PART NUMBER	TUBE OD	PRESSURE	PRICE
FK-BOSSML302	3 mm	3000 psi	£153.45
FK-BOSSML605	6 mm	3000 psi	£191.80
FK-BOSSML805	8 mm	3000 psi	£192.74
FK-BOSSML1007	10 mm	3000 psi	£294.53
FK-BOSSML1210	12 mm	3000 psi	£418.26



1756

BALL VALVES COMPRESSION

PART NUMBER	TUBE OD	PRESSURE	PRICE
FK-BVSSML302	3 mm	1500 psi	£176.50
FK-BVSSML605	6 mm	1500 psi	£189.54
FK-BVSSML806	8 mm	1500 psi	£212.63
FK-BVSSML1006	10 mm	1500 psi	£257.48
FK-BVSSML1210	12 mm	1500 psi	£382.68
FK-BVSSML1610	16 mm	1500 psi	£436.15
FK-BVSSML2010	20 mm	1500 psi	£515.46



1756

BALL VALVES 3 PORT – COMPRESSION

PART NUMBER	TUBE OD	PRESSURE	PRICE
FK-BOSSML3023L	3 mm	3000 psi	£234.16
FK-BOSSML6053L	6 mm	3000 psi	£304.04
FK-BOSSML10073L	10 mm	3000 psi	£374.69
FK-BOSSML12103L	12 mm	3000 psi	£552.28



1756

BALL VALVES 3 PORT – COMPRESSION

PART NUMBER	TUBE OD	PRESSURE	PRICE
FK-BVSSML3023	3 mm	1500 psi	£262.48
FK-BVSSML6053	6 mm	1500 psi	£282.29
FK-BVSSML10063	10 mm	1500 psi	£356.77
FK-BVSSML12103	12 mm	1500 psi	£554.37
FK-BVSSML16103	16 mm	1500 psi	£569.74
FK-BVSSML20103	20 mm	1500 psi	£669.57

METRIC NEEDLE & CHECK VALVES



1756

NEEDLE VALVES C/W REGULATING STEM

PART NUMBER	TUBE OD	PRESSURE	PRICE
FK-NGHSSML67RY	6 mm	5000 psi	£157.10
FK-NGHSSML108RY	10 mm	5000 psi	£200.85
FK-NGHSSML128RY	12 mm	5000 psi	£213.13



1756

CHECK VALVES

PART NUMBER	TUBE OD	PRESSURE	PRICE
FK-CVSSML61	6 mm	3000 psi	£111.78
FK-CVSSML81	8 mm	3000 psi	£209.99
FK-CVSSML101	10 mm	3000 psi	£216.31
FK-CVSSML121	12 mm	3000 psi	£234.90

SPECIFICATIONS	300 SERIES	99 & 310 SERIES	400 & 410 SERIES	HP SERIES
Temperature range	-46°C to +230°C	-51°C to +232°C	-23°C to +191°C	18°C to 121°C
Cracking pressure	–	–	1/3 psi other cracking pressures available on request	–

IMPERIAL VALVES

NEEDLE VALVES C/W REGULATING STEM NPT FEMALE



1756

PART NUMBER	THREAD	PRESSURE	PRICE
FK-NGHSSFNS47RY	1/4" NPT	5000 psi	£187.21
FK-NGHSSFNS68RY	3/8" NPT	5000 psi	£200.85
FK-NGHSSFNS89RY	1/2" NPT	5000 psi	£210.37

NEEDLE VALVES C/W REGULATING STEM BSPT FEMALE



1756

PART NUMBER	THREAD	PRESSURE	PRICE
FK-NGHSSFRT27RY	1/8" BSPT	5000 psi	£126.26
FK-NGHSSFRT47RY	1/4" BSPT	5000 psi	£126.26

CHECK VALVES



1756

PART NUMBER	TUBE OD	PRESSURE	PRICE
FK-CVSSF21	1/8"	3000 psi	£126.53
FK-CVSSF41	1/4"	3000 psi	£111.78
FK-CVSSF61	3/8"	3000 psi	£216.31
FK-CVSSF81	1/2"	3000 psi	£234.90

CHECK VALVES NPT FEMALE



1756

PART NUMBER	THREAD	PRESSURE	PRICE
FK-CVSSFNS21	1/8" NPT	3000 psi	£110.42
FK-CVSSFNS41	1/4" NPT	3000 psi	£110.42
FK-CVSSFNS61	3/8" NPT	3000 psi	£206.38
FK-CVSSFNS81	1/2" NPT	3000 psi	£224.03

NEEDLE VALVES C/W REGULATING STEM COMPRESSION



1756

PART NUMBER	TUBE OD	PRESSURE	PRICE
FK-NGHSSFL47RY	1/4"	5000 psi	£172.81
FK-NGHSSFL68RY	3/8"	5000 psi	£185.11
FK-NGHSSFL88RY	1/2"	5000 psi	£213.13

RELIEF VALVES PRESSURE: 1500 – 2250 PSI



1756

PART NUMBER	INLET	OUTLET	PRICE
FK-RVSSFL46P	1/4" OD	1/4" OD	£262.48
FK-RVSSML66P	6 mm OD	6 mm OD	£262.40
FK-RVSSNS4FL46P	1/4" NPT male	1/4" OD	£256.16
FK-RVSSNS4FNS46P	1/4" NPT male	1/4" NPT female	£249.83

RELIEF VALVE SPRINGS

PRESSURE: 50 – 6000 PSI



1756

PART NUMBER	SPRING COLOUR	PRESSURE	PRICE
FK-7PRVSP6F	Green	50 – 300 psi	£5.89
FK-7PRVSP6O	Orange	300 – 700 psi	£8.19
FK-7PRVSP6Y	Yellow	700 – 1500 psi	£9.27
FK-7PRVSP6P	Purple	1500 – 2500 psi	£10.17
FK-7PRVSP6W	White	2500 – 3500 psi	£11.02
FK-7PRVSP6J	Blue	3500 – 4500 psi	£11.91
FK-7PRVSP6C	Red	4500 – 6000 psi	£12.80

* Only one spring supplied – colour relates to pressure rating



1756

**PANEL MOUNT
NPT FEMALE – IMPERIAL**

PART NUMBER	THREAD	PRESSURE	PRICE
FK-BOSSFNS203	1/8" NPT	2500 psi	£161.68
FK-BOSSFNS407	1/4" NPT	2500 psi	£286.89
FK-BOSSFNS607	3/8" NPT	2500 psi	£280.02
FK-BOSSFNS810	1/2" NPT	2500 psi	£430.14



1756

**ANGLE PATTERN
NPT FEMALE – IMPERIAL**

PART NUMBER	THREAD	TUBE OD	PRESSURE	PRICE
FK-NGSSFNS25RY	1/8" NPT	1/8"	3000 psi	£126.26
FK-NGSSFNS48RY	1/4" NPT	1/4"	3000 psi	£176.93
FK-NGSSFNS68RY	3/8" NPT	3/8"	3000 psi	£200.91
FK-NGSSFNS89RY	1/2" NPT	1/2"	3000 psi	£210.45
FK-NGSSFNS129RY	3/4" NPT	3/4"	3000 psi	£219.84



1756

**PANEL MOUNT
IMPERIAL**

PART NUMBER	TUBE OD	PRESSURE	PRICE
FK-NGSSFSL25RY	1/8"	3000 psi	£165.13
FK-NGSSFSL47RY	1/4"	3000 psi	£161.10
FK-NGSSFSL68RY	3/8"	3000 psi	£185.11
FK-NGSSFSL88RY	1/2"	3000 psi	£213.13
FK-NGSSFSL129RY	3/4"	3000 psi	£328.09



1756

**ANGLE PATTERN
IMPERIAL**

PART NUMBER	TUBE OD	PRESSURE	PRICE
FK-NGSSFSL25RYA	1/8"	3000 psi	£206.49
FK-NGSSFSL47RYA	1/4"	3000 psi	£201.41
FK-NGSSFSL68RYA	3/8"	3000 psi	POA
FK-NGSSFSL88RYA	1/2"	3000 psi	£266.37
FK-NGSSFSL129RYA	3/4"	3000 psi	POA



1756

**PANEL MOUNT
METRIC**

PART NUMBER	TUBE OD	PRESSURE	PRICE
FK-NGSSML35RY	3 mm	3000 psi	£165.21
FK-NGSSML67RY	6 mm	3000 psi	£161.07
FK-NGSSML87RY	8 mm	3000 psi	£161.97
FK-NGSSML108RY	10 mm	3000 psi	£200.48
FK-NGSSML128RY	12 mm	3000 psi	£231.25



1756

**ANGLE PATTERN
METRIC**

PART NUMBER	TUBE OD	PRESSURE	PRICE
FK-NGSSML35RYA	3 mm	3000 psi	POA
FK-NGSSML67RYA	6 mm	3000 psi	POA
FK-NGSSML87RYA	8 mm	3000 psi	£200.44
FK-NGSSML108RYA	10 mm	3000 psi	£250.61
FK-NGSSML128RYA	12 mm	3000 psi	POA



1756

**PANEL MOUNT
BSPT FEMALE – IMPERIAL**

PART NUMBER	THREAD	PRICE
FK-NGSSFRT25RY	1/8" BSPT	POA
FK-NGSSFRT48RY	1/4" BSPT	POA
FK-NGSSFRT68RY	3/8" BSPT	POA
FK-NGSSFRT89RY	1/2" BSPT	£201.41
FK-NGSSFRT129RY	3/4" BSPT	POA



1756

**PANEL MOUNT
IMPERIAL**

PART NUMBER	TUBE OD	PRESSURE	PRICE
FK-NBSSFSL47RY	1/4"	1500 psi	£253.40
FK-NBSSFSL68RY	3/8"	1500 psi	POA
FK-NBSSFSL88RY	1/2"	1500 psi	POA
FK-NBSSFSL129RY	3/4"	1500 psi	POA



**PANEL MOUNT
METRIC**

PART NUMBER	TUBE OD	PRESSURE	PRICE
FK-NBSSML67RY	6 mm	6000 psi	£253.40
FK-NBSSML87RY	8 mm	6000 psi	£262.48
FK-NBSSML108RY	10 mm	6000 psi	£200.48
FK-NBSSML128RY	12 mm	6000 psi	£231.25
FK-NBSSML169RY	16 mm	6000 psi	POA
FK-NBSSML209RY	20 mm	6000 psi	POA

**ANGLE PATTERN
IMPERIAL**

PART NUMBER	TUBE OD	PRESSURE	PRICE
FK-NBSSFL47RYA	1/4"	1500 psi	POA
FK-NBSSFL68RYA	3/8"	1500 psi	POA
FK-NBSSFL88RYA	1/2"	1500 psi	£360.88
FK-NBSSFL129RYA	3/4"	1500 psi	POA



**PANEL MOUNT
BSPT FEMALE – IMPERIAL**

PART NUMBER	THREAD	PRESSURE	PRICE
FK-NBSSFRT27RY	1/8" BSPT	6000 psi	POA
FK-NBSSFRT48RY	1/4" BSPT	6000 psi	£251.62
FK-NBSSFRT68RY	3/8" BSPT	6000 psi	£253.35
FK-NBSSFRT89RY	1/2" BSPT	6000 psi	POA
FK-NBSSFRT129RY	3/4" BSPT	6000 psi	£380.36

**ANGLE PATTERN
METRIC**

PART NUMBER	TUBE OD	PRESSURE	PRICE
FK-NBSSML67RYA	6 mm	6000 psi	POA
FK-NBSSML87RYA	8 mm	6000 psi	£319.05
FK-NBSSML108RYA	10 mm	6000 psi	£250.61
FK-NBSSML128RYA	12 mm	6000 psi	POA
FK-NBSSML169RYA	16 mm	6000 psi	POA
FK-NBSSML209RYA	20 mm	6000 psi	POA



**PANEL MOUNT
NPT FEMALE – IMPERIAL**

PART NUMBER	THREAD	PRESSURE	PRICE
FK-NBSSFNS27RY	1/8" NPT	6000 psi	POA
FK-NBSSFNS48RY	1/4" NPT	6000 psi	POA
FK-NBSSFNS68RY	3/8" NPT	6000 psi	£253.35
FK-NBSSFNS89RY	1/2" NPT	6000 psi	£378.23
FK-NBSSFNS129RY	3/4" NPT	6000 psi	£380.94

IMPERIAL COUPLINGS



**QUICK RELEASE COUPLINGS
VALVED**

PART NUMBER	TUBE OD	PRICE
FK-SSQC4FL4B	1/4"	£84.38
FK-SSQC6FL6B	3/8"	£96.30
FK-SSQC8FL8B	1/2"	£139.91

IMPERIAL NIPPLES



**QUICK RELEASE NIPPLES
VALVED**

PART NUMBER	TUBE OD	PRICE
FK-SSQC4FL4D	1/4"	£65.77
FK-SSQC6FL6D	3/8"	£79.11
FK-SSQC8FL8D	1/2"	£110.39

**QUICK RELEASE NIPPLES
UNVALVED**

PART NUMBER	TUBE OD	PRICE
FK-SSQC4FL4S	1/4"	£42.21
FK-SSQC6FL6S	3/8"	£62.89
FK-SSQC8FL8S	1/2"	£80.74



High Pressure Ball Valves

Description

2-way, side mounted high pressure ball valves

Applications

- Hydraulics, particularly in construction
- Agricultural
- Water engineering
- Mining
- Paint industries

Specifications

Working pressure: 1/4" to 1/2" – 500 bar
 3/4" to 1 1/2" – 315 bar
 Temperature range: -20°C to +120°C (-4°F to +248°F)

Materials

Block & connection: carbon steel
 Ball & stem: carbon steel
 Ball seat: PTFE
 Connection & stem seal: NBR

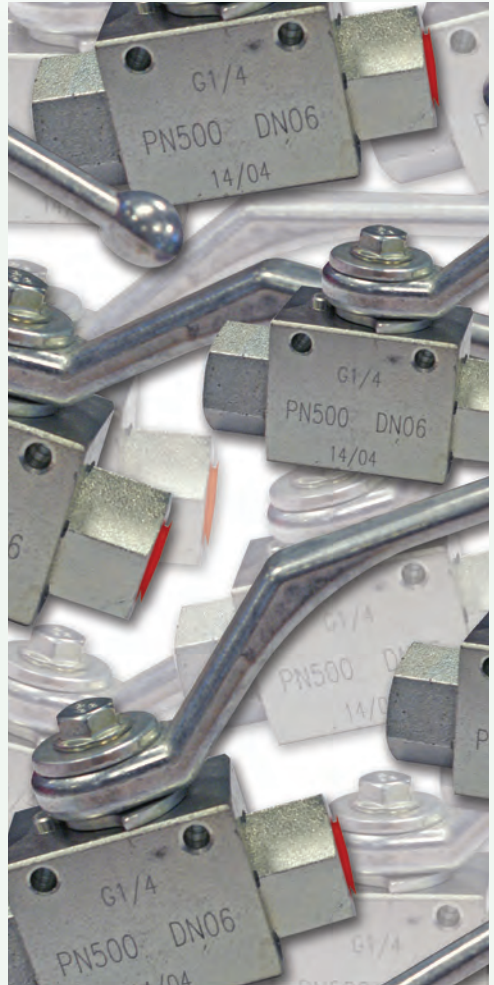

HIGH PRESSURE BALL VALVES



**HBV SERIES 2-WAY
BSPP FEMALE**

2235

PART NUMBER	BODY SIZE	THREAD	PRESSURE	PRICE
B/VHBV-WM-G04	1/4"	1/4" BSPP	500 bar	£19.99
B/VHBV-WM-G06	3/8"	3/8" BSPP	500 bar	£25.75
B/VHBV-WM-G08	1/2"	1/2" BSPP	500 bar	£28.53
B/VHBV-WM-G12	3/4"	3/4" BSPP	315 bar	£41.43
B/VHBV-WM-G16	1"	1" BSPP	315 bar	£61.48
B/VHBV-WM-G20	1"	1 1/4" BSPP	315 bar	£82.54
B/VHBV-WM-G24	1"	1 1/2" BSPP	315 bar	£103.93

Do you also need?



Hydraulic needle valves



Find it on page 443, section seven



Rötelmann Valves

2-Way Ball Valves

Rötelmann manufactures 2-way ball valves using stainless steel, steel, and aluminium to withstand up to 1500 bar pressures. These valves come in various configurations to cater to different applications. For instance, they can be automated using pneumatic, electric, or hydraulic actuators and equipped with limit switches, proximity switches, locking devices, and detents. In addition, the company produces all common types of thread, flange, and plug connectors, as well as ball valves for manifold mounting and insertion in cartridge form.

- Nominal diameters from 4 to 127
- High-grade materials like steel, stainless steel or aluminium for pressures up to 1500 bar (21,750 psi)
- Zinc nickel plating gives up to 1000 hours of resistance in salt spraying tests
- With optional pneumatic, electric or hydraulic actuator
- Also available with limit switches, proximity switches or locking devices

Multi-Way Ball Valves

Rötelmann manufactures multi-way ball valves in nominal widths from DN 4 to DN 65. These valves come with either a floating ball or a trunnion ball. DN 65 is only available for manifold valves, and threaded connections are available up to DN 50. They are also available for pipe mounting, various mounting, and manifold insertion. The enclosures are made from stainless steel, steel, or aluminium, designed for up to 500 bar use. Rötelmann offers the option to supply these multi-way ball valves with pneumatic, electric, or hydraulic actuators and limit switches, proximity switches, and locking devices for precise automatic control.

- Nominal diameters from 4 to 65
- Nominal pressures up to 500 bar (7250 psi)
- Zinc nickel plating gives up to 1000 hours of resistance in salt spraying test
- With optional pneumatic, electric or hydraulic actuator
- Also available with limit switch, proximity switch, locking device or detent

Valves

Rötelmann's needle, check, and flow control valves have thread connections ranging from DN 4 to DN 50. The enclosures and spindles, or threaded connectors, are made of steel.

Check Valves

- With threaded connector: Steel DN 4 – DN 50
- Full flow, no reduction
- Custom orders available upon request
- Opening pressures: 1 bar for DN 4 and DN 6, 0.5 bar for all other sizes
- Available with BSP connector ISO 228-1 and with connectors for light and heavy range series according to DIN 2353
- Also available in stainless steel

Needle Valves

- DN 4 to DN 50
- Body and spindle of steel, rotary aluminium knob (closed design)
- PN: 350 bar
- Custom orders available upon request
- Also available in stainless steel

Flow Control Valves

- DN 4 to DN 50
- Body and spindle of steel, rotary aluminium knob (closed design)
- PN: 350 bar
- Opening pressure: 0.5 bar
- Custom orders available upon request
- Also available in stainless steel

All technical information and dimensions are subject to change. Please get in touch with your distributor for further information.



2-WAY – STEEL – DN4–DN40/25

MATERIALS

Body	Zinc nickel plated
Ball	Steel, hard chrome plated
Stem	Steel, zinc plated
Ball seals	POM
Stem seals	NBR
Handle	Zinc, die cast



2-WAY BALL VALVE
BSPP FEMALE – ISO 228-1

2225

PART NUMBER	DN	THREAD	MAX. PRESSURE	SPARE HANDLE CODE	PRICE
B/VBKH-02	4	1/8" BSPP	500 bar	12	£118.85
B/VBKH-04	6	1/4" BSPP	500 bar	12	£29.82
B/VBKH-06	10	3/8" BSPP	500 bar	13	£34.11
B/VBKH-08	12	1/2" BSPP	500 bar	14	£43.45
B/VBKH-10	16	5/8" BSPP	420 bar	14	POA
B/VBKH-12	20	3/4" BSPP	420 bar	15	£73.18
B/VBKH-16	25	1" BSPP	420 bar	15	£96.93
B/VBKH-20	32/25	1 1/4" BSPP	420 bar	15	£112.70
B/VBKH-24	40/25	1 1/2" BSPP	420 bar	15	POA



2-WAY BALL VALVE
LIGHT SERIES DIN2353
METRIC MALE

2225

PART NUMBER	DN	THREAD	MAX. PRESSURE	SPARE HANDLE CODE	PRICE
B/VBKH-6L	4	M12 x 1.5	500 bar	12	POA
B/VBKH-8L	6	M14 x 1.5	500 bar	12	£31.21
B/VBKH-10L	8	M16 x 1.5	500 bar	13	£38.59
B/VBKH-12L	10	M18 x 1.5	500 bar	13	£38.32
B/VBKH-15L	12	M22 x 1.5	500 bar	14	£49.35
B/VBKH-18L	16	M26 x 1.5	420 bar	14	£60.99
B/VBKH-22L	20	M30 x 2	420 bar	15	£70.34
B/VBKH-28L	25	M36 x 2	420 bar	15	£96.74
B/VBKH-35L	32/25	M45 x 2	420 bar	15	£109.26
B/VBKH-42L	40/25	M52 x 2	420 bar	15	£176.05



2-WAY BALL VALVE
HEAVY SERIES DIN2353
METRIC MALE

2225

PART NUMBER	DN	THREAD	MAX. PRESSURE	SPARE HANDLE CODE	PRICE
B/VBKH-8S	4	M16 x 1.5	500 bar	12	£45.70
B/VBKH-10S	6	M18 x 1.5	500 bar	12	£33.72
B/VBKH-12S	8	M20 x 1.5	500 bar	13	£45.16
B/VBKH-14S	10	M22 x 1.5	500 bar	13	£43.83
B/VBKH-16S	12	M24 x 1.5	500 bar	14	£47.66
B/VBKH-20S	16	M30 x 1.5	420 bar	14	£60.23
B/VBKH-25S	20	M36 x 2	420 bar	15	£83.89
B/VBKH-30S	25	M42 x 2	420 bar	15	£181.24
B/VBKH-38S	32/25	M52 x 2	420 bar	15	£184.30

3-WAY – STEEL – DN4–DN40/25

MATERIALS

Cycling	90°
Body	Zinc nickel plated
Ball	Steel, hard chrome plated
Stem	Steel, zinc plated
Ball seals	POM
Stem seals	NBR
Handle	Zinc, die cast



3-WAY BALL VALVE
T PORTED
BSPP FEMALE – ISO 228-1

2225

PART NUMBER	DN	THREAD	MAX. PRESSURE	SPARE HANDLE CODE	PRICE
B/VBK3-02T	4	1/8" BSPP	500 bar	12	POA
B/VBK3-04T	6	1/4" BSPP	500 bar	12	POA
B/VBK3-06T	10	3/8" BSPP	500 bar	13	POA
B/VBK3-08T	12	1/2" BSPP	500 bar	14	POA
B/VBK3-12T	20	3/4" BSPP	400 bar	15	POA
B/VBK3-16T	25	1" BSPP	400 bar	15	POA
B/VBK3-20T	32/25	1 1/4" BSPP	400 bar	15	POA
B/VBK3-24T	40/25	1 1/2" BSPP	400 bar	15	POA



3-WAY BALL VALVE
L PORTED
BSPP FEMALE – ISO 228-1

2225

PART NUMBER	DN	THREAD	MAX. PRESSURE	SPARE HANDLE CODE	PRICE
B/VBK3-02L	4	1/8" BSPP	500 bar	12	POA
B/VBK3-04L	6	1/4" BSPP	500 bar	12	POA
B/VBK3-06L	10	3/8" BSPP	500 bar	13	POA
B/VBK3-08L	12	1/2" BSPP	500 bar	14	POA
B/VBK3-12L	20	3/4" BSPP	400 bar	15	POA
B/VBK3-16L	25	1" BSPP	400 bar	15	POA
B/VBK3-20L	32/25	1 1/4" BSPP	400 bar	15	POA
B/VBK3-24L	40/25	1 1/2" BSPP	400 bar	15	POA

2 WAY – STAINLESS STEEL – DN4–DN25

MATERIALS

Body, ball & stem	Stainless steel
Ball seals	POM
Stem seals	FKM
Handle	Zinc, die cast
Stop plate	Steel, zinc plated



2 WAY BALL VALVE

BSPP FEMALE – ISO 228-1

2225

PART NUMBER	DN	THREAD	MAX. PRESSURE	SPARE HANDLE CODE	PRICE
B/VBKHSS-02	4	1/8" BSPP	500 bar	12/32	£158.40
B/VBKHSS-04	6	1/4" BSPP	500 bar	12/32	£151.80
B/VBKHSS-06	10	3/8" BSPP	500 bar	13/33	£168.30
B/VBKHSS-08	12	1/2" BSPP	500 bar	14/34	£204.60
B/VBKHSS-12	20	3/4" BSPP	420 bar	14/34	£349.44
B/VBKHSS-16	25	1" BSPP	420 bar	15/35	£396.48

HANDLES

SPARE HANDLES

STEEL – DN4–DN40/25

2225



PART NUMBER	HANDLE CODE	FOR USE WITH	PRICE
B/V903709	12	1/8" to 1/4"	£5.76
B/V903708	13	3/8"	£5.76
B/V903706	14	1/2"	£7.68
B/V903694	15	3/4" to 1 1/2"	£15.36



SPARE HANDLES

STAINLESS STEEL – DN4–DN25

2225

PART NUMBER	HANDLE CODE	FOR USE WITH	PRICE
B/V903749	32	1/8" to 1/4"	£38.40
B/V903750	33	3/8"	POA
B/V903751	34	1/2" to 3/4"	£48.00
B/V903752	35	1"	£57.60

Locking mechanisms also available

Please contact your distributor for further information

CHECK VALVES – STEEL – DN4–DN32

MATERIALS

Body	Steel, zinc plated
Seat	POM
O-rings	FKM
Opening pressures	1 bar for DN 4 & DN 6 0.5 bar for all other sizes



CHECK VALVE

BSPP FEMALE – ISO 228-1

2225

PART NUMBER	DN	THREAD	MAX. PRESSURE	PRICE
B/VNVRV-02	4	1/8" BSPP	420 bar	£67.86
B/VNVRV-04	6	1/4" BSPP	420 bar	£59.67
B/VNVRV-06	10	3/8" BSPP	420 bar	£64.69
B/VNVRV-08	12	1/2" BSPP	420 bar	£107.52
B/VNVRV-12	20	3/4" BSPP	420 bar	£114.43
B/VNVRV-16	25	1" BSPP	420 bar	£125.06
B/VNVRV-20	32	1 1/4" BSPP	420 bar	£583.69

NEEDLE VALVES – STEEL – DN4–DN32

MATERIALS

Body	Steel, zinc plated
Spindle	Steel
Rotary knob	Aluminium
O-rings	FKM



NEEDLE VALVE – BIDIRECTIONAL

BSPP FEMALE – ISO 228-1

2225

PART NUMBER	DN	THREAD	MAX. PRESSURE	PRICE
B/VNDV-02	4	1/8" BSPP	350 bar	£26.69
B/VNDV-04	6	1/4" BSPP	350 bar	£24.51
B/VNDV-06	10	3/8" BSPP	350 bar	£25.31
B/VNDV-08	12	1/2" BSPP	350 bar	£31.40
B/VNDV-12	20	3/4" BSPP	350 bar	£47.27
B/VNDV-16	25	1" BSPP	350 bar	£98.37
B/VNDV-20	32	1 1/4" BSPP	350 bar	£113.54

HIGH PRESSURE FLOW CONTROL VALVES – STEEL – DN4–DN32

MATERIALS

Body	Steel, zinc plated
Spindle	Steel
Rotary knob	Aluminium
O-rings	FKM
Opening pressures	1 bar for DN 4 & DN 6 0.5 bar for all other sizes



FLOW CONTROL VALVE – 1 WAY

BSPP FEMALE – ISO 228-1

2225

PART NUMBER	DN	THREAD	MAX. PRESSURE	PRICE
B/VNDRV-02	4	1/8" BSPP	350 bar	£38.55
B/VNDRV-04	6	1/4" BSPP	350 bar	£34.86
B/VNDRV-06	10	3/8" BSPP	350 bar	£43.12
B/VNDRV-08	12	1/2" BSPP	350 bar	£48.36
B/VNDRV-12	20	3/4" BSPP	350 bar	£57.42
B/VNDRV-16	25	1" BSPP	350 bar	£119.72
B/VNDRV-20	32	1 1/4" BSPP	350 bar	£142.38

CHECK VALVES

SPECIFICATIONS

Fluid viscosity	10 – 500 mm 2/5 45 – 2000 ssu (6 – 420 cSt)
Filtration	ISO code 16/13 SAE class 4 or better
Fluid temperature	-20°C to +80°C (-4°F to +176°F)
Ambient temperature	-20°C to +50°C (-4°F to +122°F)
Cracking pressure	0.5 bar

VUR-BSPP SERIES
BALL TYPE – BSPP FEMALE



8025

PART NUMBER	THREAD	MAX. PRESSURE	PRICE
DCA-VUR180SF0.5	1/8" BSPP	400 bar	£12.05
DCA-VUR140SF0.5	1/4" BSPP	350 bar	£10.06
DCA-VUR380SF0.5	3/8" BSPP	350 bar	£12.34
DCA-VUR120SF0.5	1/2" BSPP	320 bar	£15.37

POPPET TYPE – BSPP FEMALE

PART NUMBER	THREAD	MAX. PRESSURE	PRICE
DCA-VUR340SP0.5	3/4" BSPP	300 bar	£28.16
DCA-VUR100SP0.5	1" BSPP	250 bar	£41.74
DCA-VUR114SP0.5	1 1/4" BSPP	250 bar	£82.56
DCA-VUR112SP0.5	1 1/2" BSPP	210 bar	£97.29
DCA-VUR200SP0.5	2" BSPP	150 bar	£157.66

SHUTTLE BALL VALVES

SPECIFICATIONS

Fluid viscosity	10 – 500 mm 2/5 45 – 2000 ssu (6 – 420 cSt)
Filtration	ISO code 16/13 SAE class 4 or better
Fluid temperature	-20°C to +80°C (-4°F to +176°F)
Ambient temperature	-20°C to +50°C (-4°F to +122°F)

VUSF SERIES
BSPP FEMALE



8025

PART NUMBER	THREAD	MAX. PRESSURE	PRICE
DCA-VUSF140N	1/4" BSPP	350 bar	£27.80
DCA-VUSF380N	3/8" BSPP	350 bar	£27.80
DCA-VUSF120N	1/2" BSPP	350 bar	£43.96

FLOW CONTROL VALVES

SPECIFICATIONS

Fluid viscosity	10 – 500 mm 2/5 45 – 2000 ssu (6 – 420 cSt)
Filtration	ISO code 16/13 SAE class 4 or better
Fluid temperature	-20°C to +80°C (-4°F to +176°F)
Ambient temperature	-20°C to +50°C (-4°F to +122°F)

VURF SERIES – BARREL TYPE
UNIDIRECTIONAL
BSPP FEMALE



8025

PART NUMBER	THREAD	PRICE
DCA-VURF140	1/4" BSPP	£42.96
DCA-VURF380	3/8" BSPP	£47.91
DCA-VURF340	3/4" BSPP	£85.47

BIDIRECTIONAL – BSPP FEMALE

PART NUMBER	THREAD	PRICE
DCA-VBRF140	1/4" BSPP	£40.79
DCA-VBRF380	3/8" BSPP	£42.96
DCA-VBRF120	1/2" BSPP	£44.95
DCA-VBRF340	3/4" BSPP	£78.42

STUF-BSPP SERIES
UNIDIRECTIONAL – BSPP FEMALE



8025

PART NUMBER	THREAD	MAX. PRESSURE	PRICE
DCA-STUF140	1/4" BSPP	400 bar	£34.08
DCA-STUF380	3/8" BSPP	400 bar	£34.08
DCA-STUF120	1/2" BSPP	400 bar	£41.67
DCA-STUF340	3/4" BSPP	400 bar	£81.81
DCA-STUF100	1" BSPP	250 bar	£114.06

STBF-BSP SERIES
BIDIRECTIONAL – BSPP FEMALE



8025

PART NUMBER	THREAD	MAX. PRESSURE	PRICE
DCA-STBF140	1/4" BSPP	400 bar	£29.49
DCA-STBF380	3/8" BSPP	400 bar	£30.19
DCA-STBF120	1/2" BSPP	400 bar	£37.06
DCA-STBF340	3/4" BSPP	400 bar	£69.00
DCA-STBF100	1" BSPP	250 bar	£94.65

SOLENOID VALVES



FEATURES

- Suitable for high pressure applications with low flow rates
- Can be used on vacuum technology applications
- Valves respond from 0 bar up to the max. operating pressure
- Designed to be unaffected by slight contamination
- Low leakage
- 2/2 in-line poppet valves
- Sealing material FKM
- 24 V DC solenoid coil with 3 pin plug socket
- Brass body



3110

VZWD MEDIA SOLENOID VALVE
15 BAR MAXIMUM PRESSURE

PART NUMBER	TYPE	PORT SIZE	NOMINAL BORE	PRICE
FES1491827	VZWD-L-M22C-M-G18-20-V-1P4-15	1/8"	2.0 mm	£50.56
FES1491836	VZWD-L-M22C-M-G18-15-V-1P4-30	1/8"	3.0 mm	£70.46
FES1491830	VZWD-L-M22C-M-G14-20-V-1P4-15	1/4"	2.0 mm	£58.22
FES1491844	VZWD-L-M22C-M-G14-30-V-1P4-15	1/4"	3.0 mm	£67.42

8 BAR MAXIMUM PRESSURE

FES1491837	VZWD-L-M22C-M-G18-40-V-1P4-8	1/8"	4.0 mm	£81.22
FES1491845	VZWD-L-M22C-M-G14-40-V-1P4-8	1/4"	4.0 mm	£81.22

4 BAR MAXIMUM PRESSURE

FES1491839	VZWD-L-M22C-M-G18-60-V-1P4-4	1/8"	6.0 mm	£81.22
FES1491847	VZWD-L-M22C-M-G14-60-V-1P4-4	1/4"	6.0 mm	£81.22

FEATURES

- Can be used in applications such as cooling of filling systems, vacuum & bottling
- Forced lifting of the diaphragm valve via servo hole
- Operates with no differential pressure between inlet & outlet
- Medium pressure – 0 bar or higher
- 2/2 in-line valve
- Sealing material NBR
- 24 V DC solenoid coil with 3 pin plug socket
- Brass body



3110

VZWF FORCE PILOT OPERATED SOLENOID VALVE
10 BAR MAXIMUM PRESSURE, 13.5 MM NOMINAL BORE

PART NUMBER	TYPE	PROCESS VALVE CONNECTION	PRICE
FES1492110	VZWF-B-L-M22C-G14-135-1P4-10	G1/4	£80.45
FES1492111	VZWF-B-L-M22C-G38-135-1P4-10	G3/8	£80.45
FES1492112	VZWF-B-L-M22C-G12-135-1P4-10	G1/2	£80.45

6 BAR MAXIMUM PRESSURE, 27.5 MM NOMINAL BORE

FES1492113	VZWF-B-L-M22C-G34-275-1P4-6	G3/4	£128.73
FES1492114	VZWF-B-L-M22C-G1-275-1P4-6	G1	£128.73

DIAPHRAGM VALVES



FEATURES

- Indirectly controlled poppet valve with diaphragm control
- Connection – valve G1/4" to G2"
- Brass body
- Varied range of coils
- Flow rate, 1400 to 31,000 l/min



3110

VZWM-L DIAPHRAGM VALVE

PART NUMBER	TYPE	ARMATURE TUBE	PORT SIZE	PRICE
FES546146	VZWM-L-M22C-G14-F4	F4	1/4"	£81.80
FES546147	VZWM-L-M22C-G38-F4	F4	3/8"	£81.80
FES546148	VZWM-L-M22C-G12-F4	F4	1/2"	£81.80
FES546149	VZWM-L-M22C-G34-F4	F4	3/4"	£129.01
FES546150	VZWM-L-M22C-G1-F4	F4	1"	£129.01
FES546152	VZWM-L-M22C-G112-F5	F5	1 1/2"	£341.46
FES546151	VZWM-L-M22C-G114-F5	F5	1 1/4"	£341.46
FES546153	VZWM-L-M22C-G2-F5	F5	2"	£394.94



ANGLE SEAT VALVE

FEATURES

- Low flow resistance
- Insensitive to steam or slightly contaminated media
- Long service life
- Low maintenance
- High chemical & thermal resistance
- Angle seat valves are simple & sturdy, suitable for viscosity of up to 600 mm²/s
- Brass body
- NBR seal



3110

VZXF ANGLE SEAT VALVE
2/2 WAY, NORMALLY CLOSED

PART NUMBER	TYPE	PROCESS VALVE CONNECTION	MEDIUM PRESSURE (BAR)	PRICE
FES1002501	VZXF-L-M22C-M-B-G12-120-H3B1-50-16	G1/2"	16	£137.11
FES1002503	VZXF-L-M22C-M-B-G34-160-H3B1-50-16	G3/4"	16	£144.78
FES1002505	VZXF-L-M22C-M-B-G1-230-H3B1-50-10	G1"	10	£156.16
FES1002509	VZXF-L-M22C-M-B-G112-350-H3B1-50-6	G1 1/2"	6	£208.90
FES1002511	VXZF-L-M22C-M-B-G2-430-H3B1-50-3	G2"	3	£249.56

FEATURES

- Highly flexible, extremely high flow rates
- Long service life
- Stainless steel or Ecobross angle seat fittings with stainless steel or polymer actuators



3110

VZXA ANGLE SEAT VALVE
2/2 WAY, NORMALLY CLOSED

PART NUMBER	TYPE	PROCESS VALVE CONNECTION	MEDIUM PRESSURE (BAR)	PRICE
FES8060530	VZXA-B-TS6-25-M2-V13T-8.3-K-46-17-V4	G1"	5 to 10	£307.27
FES8060528	VZXA-B-TS6-20-M2-V13T-12.8-K-46-17-V4	G 3/4"	5 to 10	£286.80
FES8060527	VZXA-B-TS6-13-M2-V13T-30-K-46-17-V4	G1/2"	0 to 30	£277.74

ACTUATED PROCESS VALVES

FEATURES

- Combined pneumatic quarter turn actuator & ball valve
- Flow is fully opened or closed in both directions
- Limit switch attachments for end position sensing, can be mounted directly on unit
- Suitable for valves with port pattern to NAMUR

SPECIFICATIONS

Thread connection	G pipe with 2 pitch circle diameters of 36 & 42 mm
Nominal pressure	63 bar
Control valve	2/2-way directional
Swivel direction	Right
Nominal swivel angle	90°
End position adjustment	Closed

MATERIALS

Housing & shut-off element	316 stainless steel
Seal	Reinforced PTFE



3110

VZBA BALL VALVE & ACTUATOR UNIT

PART NUMBER	TYPE	ACTUATOR	PORT SIZE	PRICE
FES1758071	VZBA-1/2"-GG-63-T-22-F0304-V4V4T-PS15-R-90-4-C	Single acting	1/2"	£308.94
FES1809653	VZBA-1/2"-GG-63-T-22-F0304-V4V4T-PP15-R-90-C	Double acting	1/2"	£262.72
FES1758072	VZBA-3/4"-GG-63-T-22-F0304-V4V4T-PS30-R-90-4-C	Single acting	3/4"	£371.39
FES1809654	VZBA-3/4"-GG-63-T-22-F0304-V4V4T-PP30-R-90-C	Double acting	3/4"	£298.50
FES1758073	VZBA-1"-GG-63-T-22-F0405-V4V4T-PS30-R-90-4-C	Single acting	1"	£414.62
FES1809655	VZBA-1"-GG-63-T-22-F0405-V4V4T-PP30-R-90-C	Double acting	1"	£341.65



Solenoid Valves

A solenoid valve is an electromechanical device that regulates the flow rate of fluids in various systems. It is commonly used in pneumatic and hydraulic fluid power systems to control cylinders, fluid power motors, or larger industrial valves. Solenoid valves are ideal for engineers and end-users who want to operate valves without human intervention.

A solenoid valve is designed to perform various tasks, such as shutting off, releasing, dosing, distributing, and mixing fluids, depending on the system's requirements. The valve's automatic function enables it to be easily installed and used in any location where there is a need for automatic gas or fluid flow control.

Fast and reliable solenoid valves can be combined on a single manifold for efficient switching.

Types of solenoid valve:

- Water, gas, air
- Pneumatic & hydraulic solenoid
- High-pressure
- High-performance or fast-acting

There is a vast selection of products available, each intended for specific applications, such as:

- Hot & cold liquids
- Compressed air
- Steam
- Mineral oil, natural oil & other oils (with & without additives)
- Aqueous solutions
- Aggressive & combustible gas



SLP SERIES – BRASS

FEATURES

SLP 2/2 way series solenoid valves are commonly used in automation control systems, which are widely used for automatic closing & opening of all kinds of fluids, such as water, hot water, gas, liquid, light oil, etc. in pipework systems.

MAX. OPERATING PRESSURE	Air	Water	Light Oil
3/8"	16 bar	16 bar	13 bar
1/2"	16 bar	16 bar	13 bar
3/4"	16 bar	16 bar	13 bar
1"	16 bar	16 bar	13 bar

SUITABILITY	EPDM
Highest working temperature	120°C
Lowest working temperature	-20°C
Steam	Very good
Oil	Not suitable
General chemical resistance	Very good
General acid resistance	Very good
General alkalinity resistance	Very good
Water	Very good

IP65 RATED

IP65 = dust tight; full protection & protection against directed water jets of low pressure (6.3 mm) from any angle this is only if the DIN plug (DIN43650/pg9) is correctly fitted to coil with the rubber seal in place.

SLP Series includes coil & DIN plug

Normally open valves available on request



3695

SLP SERIES BRASS SOLENOID VALVE (2/2) 3/8" NORMALLY CLOSED WITH EPDM SEALS

PART NUMBER	PORT SIZE	VOLTAGE	ORIFICE SIZE	PRICE
ASLGSLPNCW038N110VAC	3/8"	110 V AC	13 mm	£148.60
ASLGSLPNCW038N230VAC	3/8"	230 V AC	13 mm	£148.60
aASLGSLPNCW038N24VAC	3/8"	24 V AC	13 mm	£148.60
aASLGSLPNCW038N24VDC	3/8"	24 V DC	13 mm	£148.60

1/2" NORMALLY CLOSED WITH EPDM SEALS

ASLGSLPNCW050N110VAC	1/2"	110 V AC	13 mm	£148.60
ASLGSLPNCW050N230VAC	1/2"	230 V AC	13 mm	£148.60
aASLGSLPNCW050N24VAC	1/2"	24 V AC	13 mm	£148.60
aASLGSLPNCW050N24VDC	1/2"	24 V DC	13 mm	£148.60

3/4" NORMALLY CLOSED WITH EPDM SEALS

ASLGSLPNCW075N110VAC	3/4"	110 V AC	20 mm	£174.83
ASLGSLPNCW075N230VAC	3/4"	230 V AC	20 mm	£174.83
aASLGSLPNCW075N24VAC	3/4"	24 V AC	20 mm	£174.83
aASLGSLPNCW075N24VDC	3/4"	24 V DC	20 mm	£174.83

1" NORMALLY CLOSED WITH EPDM SEALS

ASLGSLPNCW100N110VAC	1"	110 V AC	25 mm	£262.99
ASLGSLPNCW100N230VAC	1"	230 V AC	25 mm	£262.99
aASLGSLPNCW100N24VAC	1"	24 V AC	25 mm	£262.99
aASLGSLPNCW100N24VDC	1"	24 V DC	25 mm	£262.99

SLP SERIES ACCESSORIES



SLP SERIES COIL H SERIES

PART NUMBER	VOLTAGE	TYPE	PRICE
aASLSCOILSLPHCA110AC	110 V AC	A	£60.44
aASLSCOILSLPHCA230AC	230 V AC	A	£67.90
aASLSCOILSLPHCB24VAC	24 V AC	B	£60.44
aASLSCOILSLPHCA24VDC	24 V DC	A	£60.44
aASLSCOILSLPHCB12VDC	12 V DC	B	£60.44

Do you also need?

PARKAIR®



SLP series terminal plug

Find it on page 450, section seven

ZS SERIES – BRASS

FEATURES

ZS 2/2 way series solenoid valves are commonly used in automation control systems, which are widely used for automatic closing & opening of all kinds of fluids, such as water, hot water, gas, liquid, light oil, etc. in pipework systems.

MAX. OPERATING PRESSURE	Air	Water	Light Oil
1/4"	16 bar	16 bar	16 bar
3/8"	16 bar	16 bar	16 bar
1/2"	10 bar	10 bar	7 bar
3/4"	10 bar	10 bar	7 bar
1"	10 bar	10 bar	7 bar

Normally open valves available on request



ZS SERIES BRASS SOLENOID VALVE (2/2) 1/4" NORMALLY CLOSED WITH NBR SEALS

PART NUMBER	PORT SIZE	VOLTAGE	ORIFICE SIZE	PRICE
aASLAZSNC025N110VAC	1/4"	110 V AC	10 mm	£124.92
aASLAZSNC025N230VAC	1/4"	230 V AC	10 mm	£124.92
aASLAZSNC025N24VAC	1/4"	24 V AC	10 mm	£124.92
aASLAZSNC025N24VDC	1/4"	24 V DC	10 mm	£124.92

3/8" NORMALLY CLOSED WITH NBR SEALS

aASLAZSNC038N110VAC	3/8"	110 V AC	10 mm	£113.54
aASLAZSNC038N230VAC	3/8"	230 V AC	10 mm	£113.54
aASLAZSNC038N24VAC	3/8"	24 V AC	10 mm	£113.54
aASLAZSNC038N24VDC	3/8"	24 V DC	10 mm	£113.54

1/2" NORMALLY CLOSED WITH NBR SEALS

aASLAZSNC050N110VAC	1/2"	110 V AC	10 mm	£113.54
aASLAZSNC050N230VAC	1/2"	230 V AC	10 mm	£113.54
aASLAZSNC050N24VAC	1/2"	24 V AC	10 mm	£113.54
aASLAZSNC050N24VDC	1/2"	24 V DC	10 mm	£113.54

3/4" NORMALLY CLOSED WITH NBR SEALS

aASLAZSNC075N110VAC	3/4"	110 V AC	20 mm	£160.70
aASLAZSNC075N230VAC	3/4"	230 V AC	20 mm	£160.70
aASLAZSNC075N24VAC	3/4"	24 V AC	20 mm	£160.70
aASLAZSNC075N24VDC	3/4"	24 V DC	20 mm	£160.70

1" NORMALLY CLOSED WITH NBR SEALS

aASLAZSNC100N110VAC	1"	110 V AC	25 mm	£235.87
aASLAZSNC100N230VAC	1"	230 V AC	25 mm	£235.87
aASLAZSNC100N24VAC	1"	24 V AC	25 mm	£235.87
aASLAZSNC100N24VDC	1"	24 V DC	25 mm	£235.87

SUITABILITY

	NBR	EPDM	FKM
Highest working temperature	80°C	120°C	120°C
Lowest working temperature	-5°C	-20°C	-20°C
Steam	Not suitable	Very good	Normal
Oil	Very good	Not suitable	Very good
General chemical resistance	Normal	Very good	Very good
General acid resistance	Normal	Very good	Very good
General alkalinity resistance	Good	Very good	Very good
Water	Good	Very good	Good

IP65 RATED

IP65 = dust tight; full protection & protection against directed water jets of low pressure (6.3 mm) from any angle this is only if the DIN plug (DIN43650/pg9) is correctly fitted to coil with the rubber seal in place.

ZS Series includes coil & DIN plug

ZS SERIES BRASS SOLENOID VALVE (2/2) 1/4" NORMALLY CLOSED WITH FKM SEALS



PART NUMBER	PORT SIZE	VOLTAGE	ORIFICE SIZE	PRICE
aASLAZSNCV025110VAC	1/4"	110 V AC	10 mm	£124.92
aASLAZSNCV025230VAC	1/4"	230 V AC	10 mm	£124.92
aASLAZSNCV02524VAC	1/4"	24 V AC	10 mm	£124.92
aASLAZSNCV02524VDC	1/4"	24 V DC	10 mm	£124.92

3/8" NORMALLY CLOSED WITH FKM SEALS

aASLAZSNCV038110VAC	3/8"	110 V AC	10 mm	£118.82
aASLAZSNCV038230VAC	3/8"	230 V AC	10 mm	£118.82
aASLAZSNCV03824VAC	3/8"	24 V AC	10 mm	£118.82
aASLAZSNCV03824VDC	3/8"	24 V DC	10 mm	£118.82

1/2" NORMALLY CLOSED WITH FKM SEALS

aASLAZSNCV050110VAC	1/2"	110 V AC	10 mm	£118.82
aASLAZSNCV050230VAC	1/2"	230 V AC	10 mm	£118.82
aASLAZSNCV05024VAC	1/2"	24 V AC	10 mm	£118.82
aASLAZSNCV05024VDC	1/2"	24 V DC	10 mm	£118.82

3/4" NORMALLY CLOSED WITH FKM SEALS

aASLAZSNCV075110VAC	3/4"	110 V AC	20 mm	£167.70
aASLAZSNCV075230VAC	3/4"	230 V AC	20 mm	£167.70
aASLAZSNCV07524VAC	3/4"	24 V AC	20 mm	£167.70
aASLAZSNCV07524VDC	3/4"	24 V DC	20 mm	£167.70

1" NORMALLY CLOSED WITH FKM SEALS

aASLAZSNCV100110VAC	1"	110 V AC	25 mm	£237.58
aASLAZSNCV100230VAC	1"	230 V AC	25 mm	£237.58
aASLAZSNCV10024VAC	1"	24 V AC	25 mm	£237.58
aASLAZSNCV10024VDC	1"	24 V DC	25 mm	£237.58

ZS SERIES – STAINLESS STEEL

FEATURES

ZS 2/2 way series solenoid valves are commonly used in automation control systems, which are widely used for automatic closing & opening of all kinds of fluids, such as water, hot water, gas, liquid, light oil, etc. in pipework systems.

MAX. OPERATING PRESSURE	Air	Water	Light Oil
1/4"	16 bar	16 bar	16 bar
3/8"	16 bar	16 bar	16 bar
1/2"	10 bar	10 bar	7 bar
3/4"	10 bar	10 bar	7 bar
1"	10 bar	10 bar	7 bar

SUITABILITY	FKM
Highest working temperature	120°C
Lowest working temperature	-20°C
Steam	Normal
Oil	Very good
General chemical resistance	Very good
General acid resistance	Very good
General alkalinity resistance	Very good
Water	Good

IP65 RATED

IP65 = dust tight; full protection & protection against directed water jets of low pressure (6.3 mm) from any angle this is only if the DIN plug (DIN43650/pg9) is correctly fitted to coil with the rubber seal in place.

ZS Series includes coil & DIN plug

Normally open valves available on request



3695

ZS SERIES 316 STAINLESS STEEL SOLENOID VALVE (2/2) 3/8" NORMALLY CLOSED WITH VFKM SEALS

PART NUMBER	PORT SIZE	VOLTAGE	ORIFICE SIZE	PRICE
aASLCZSSNC038N110VAC	3/8"	110 V AC	16 mm	£235.87
aASLCZSSNC038N230VAC	3/8"	230 V AC	16 mm	£235.87
aASLCZSSNC038N24VAC	3/8"	24 V AC	16 mm	£235.87
aASLCZSSNC038N24VDC	3/8"	24 V DC	16 mm	£235.87

1/2" NORMALLY CLOSED WITH FKM SEALS

aASLCZSSNC050N110VAC	1/2"	110 V AC	16 mm	£235.87
aASLCZSSNC050N230VAC	1/2"	230 V AC	16 mm	£235.87
aASLCZSSNC050N24VAC	1/2"	24 V AC	16 mm	£235.87
aASLCZSSNC050N24VDC	1/2"	24 V DC	16 mm	£235.87

3/4" NORMALLY CLOSED WITH FKM SEALS

aASLCZSSNC075N110VAC	3/4"	110 V AC	20 mm	£247.61
aASLCZSSNC075N230VAC	3/4"	230 V AC	20 mm	£247.61
aASLCZSSNC075N24VAC	3/4"	24 V AC	20 mm	£247.61
aASLCZSSNC075N24VDC	3/4"	24 V DC	20 mm	£247.61

1" NORMALLY CLOSED WITH FKM SEALS

aASLCZSSNC100N110VAC	1"	110 V AC	25 mm	£360.89
aASLCZSSNC100N230VAC	1"	230 V AC	25 mm	£360.89
aASLCZSSNC100N24VAC	1"	24 V AC	25 mm	£360.89
aASLCZSSNC100N24VDC	1"	24 V DC	25 mm	£360.89

PUT TIMER – TO SUIT ZS & SLP

FEATURES

- Connection via coil & plug
- Used to control range of valves
- 0.5 – 10 seconds on, 30 – 45 minutes off
- LED light to indicate timing

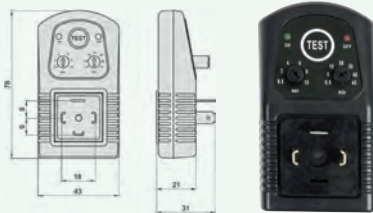

3695

PUT TIMER

PART NUMBER	DESCRIPTION	PRICE
aASLSTIMERPUT	PUT timer	£90.27

TERMINAL PLUG



3695

TERMINAL PLUG FOR ZS / SLP SERIES

PART NUMBER	DESCRIPTION	PRICE
aASLSSLPZSPLUG	Spare terminal plug	£5.72

PILOT OPERATED HUNG DIAPHRAGM NORMALLY CLOSED

DESCRIPTION

Pilot operated hung diaphragm valve with full orifice. Suitable to shut off liquid & gaseous fluids. Not suitable for use with dangerous fluids. 133 series is designed for closed circuit hydraulic systems & for vessels draining. 153 series is suitable for shutting off overheated water & steam.

SPECIFICATIONS	133 SERIES	153 SERIES
Functions	2/2 Normally closed	
Min. differential pressure	0 bar	0 bar
Max. differential pressure	10 bar AC / 3 bar DC	8 bar
Fluid temperature	-10°C to +90°C (14°F to 194°F)	-10°C to +140°C (14°F to 284°F)
Viscosity	5°E (37 cSt or mm²/s)	
Voltage tolerance	DC +10% -5% AC +10% -15%	+10% -15%
Duty cycle	ED 100%	

MATERIALS	133 SERIES	153 SERIES
Body	Brass	Brass
Sealing	NBR	EPDM
Diaphragm	NBR	PTFE
Internal components	Stainless steel & brass	Stainless steel
Seat	Brass	Stainless steel
Core tube	Stainless steel	Stainless steel
Shading coil	Copper	Copper

IP65 RATED

IP65 = dust tight; full protection & protection against directed water jets of low pressure (6.3 mm) from any angle this is only if the DIN plug (DIN43650/pg9) is correctly fitted to coil with the rubber seal in place.



5910



5910

**PILOT OPERATED – 2/2 NC
133 SERIES**

PART NUMBER	VOLTAGE	PORT SIZE	ORIFICE SIZE	COIL TYPE	PRICE
SL133B0103-230	230 V, 50 Hz	3/8" BSPP	10.0 mm	A	£151.91
SL133B0103-110	110 V, 50 Hz	3/8" BSPP	10.0 mm	A	£151.91
SL133B0103-245	24 V, 50 Hz	3/8" BSPP	10.0 mm	A	£151.91
SL133B0103-24	24 V DC	3/8" BSPP	10.0 mm	A	£151.91
SL133B0704-230	230 V, 50 Hz	1/2" BSPP	12.5 mm	A	£173.39
SL133B0704-110	110 V, 50 Hz	1/2" BSPP	12.5 mm	A	£173.39
SL133B0704-245	24 V, 50 Hz	1/2" BSPP	12.5 mm	A	£173.39
SL133B0704-24	24 V DC	1/2" BSPP	12.5 mm	A	£173.39
SL133B0705-230	230 V, 50 Hz	3/4" BSPP	17.0 mm	D	£203.01
SL133B0705-110	110 V, 50 Hz	3/4" BSPP	17.0 mm	D	£203.01
SL133B0705-245	24 V, 50 Hz	3/4" BSPP	17.0 mm	D	£203.01
SL133B0705-24	24 V DC	3/4" BSPP	17.0 mm	D	£203.01
SL133B0606-230	230 V, 50 Hz	1" BSPP	24.0 mm	G	£352.65
SL133B0606-110	110 V, 50 Hz	1" BSPP	24.0 mm	G	£352.65
SL133B0606-245	24 V, 50 Hz	1" BSPP	24.0 mm	G	£352.65
SL133B0606-24	24 V DC	1" BSPP	24.0 mm	E	£352.65

**PILOT OPERATED – 2/2 NC
153 SERIES**

PART NUMBER	VOLTAGE	PORT SIZE	ORIFICE SIZE	COIL TYPE	PRICE
SL153D0704-230	230 V, 50 Hz	1/2" BSPP	11.5 mm	F	£304.50
SL153D0704-110	110 V, 50 Hz	1/2" BSPP	11.5 mm	F	£304.50
SL153D0704-245	24 V, 50 Hz	1/2" BSPP	11.5 mm	F	£304.50
SL153D0705-230	230 V, 50 Hz	3/4" BSPP	17.0 mm	G	£369.18
SL153D0705-110	110 V, 50 Hz	3/4" BSPP	17.0 mm	G	£369.18
SL153D0705-245	24 V, 50 Hz	3/4" BSPP	17.0 mm	G	£369.18
SL153D506-230	230 V, 50 Hz	1" BSPP	22.0 mm	E	£565.98
SL153D506-110	110 V, 50 Hz	1" BSPP	22.0 mm	E	£565.98
SL153D506-245	24 V, 50 Hz	1" BSPP	22.0 mm	E	£565.98

Do you also need?

PARKAIR®



Spare coils

Find it on page 455, section seven

PILOT OPERATED NORMALLY CLOSED

DESCRIPTION

Diaphragm valve, pilot operated, having full orifice. Suitable to shut off liquid & gaseous fluids; suitable for shutting off overheated water & steam. Not suitable for use with dangerous fluids.

SPECIFICATIONS

Functions	2/2 normally closed
Min. differential pressure	0.4 bar
Max. differential pressure	8 bar – 3/8" to 1/2" 6 bar – 3/4" to 1"
Fluid temperature	60°C to 170°C (140°F to 338°F)
Viscosity	5°E (37 cSt or mm ² /s)
Voltage tolerance	+10% – 15%
Duty cycle	ED 100%

MATERIALS

Body	Brass
Sealing	Reinforced PTFE (polytetrafluoroethylene)
Internal components	Brass & stainless steel
Seat	Stainless steel
Core tube	Stainless steel
Shading coil	Copper

IP65 RATED

IP65 = dust tight; full protection & protection against directed water jets of low pressure (6.3 mm) from any angle this is only if the DIN plug (DIN43650/pg9) is correctly fitted to coil with the rubber seal in place.



**PILOT OPERATED – 2/2 NC
145 SERIES**

5910

PART NUMBER	VOLTAGE	PORT SIZE	ORIFICE SIZE	COIL TYPE	PRICE
SL145R203-230	230 V, 50 Hz	3/8" BSPP	10.0 mm	F	£308.68
SL145R203-110	110 V, 50 Hz	3/8" BSPP	10.0 mm	F	£308.68
SL145R203-245	24 V, 50 Hz	3/8" BSPP	10.0 mm	F	£308.68
SL145R204-230	230 V, 50 Hz	1/2" BSPP	10.0 mm	F	£286.48
SL145R204-110	110 V, 50 Hz	1/2" BSPP	10.0 mm	F	£286.48
SL145R204-245	24 V, 50 Hz	1/2" BSPP	10.0 mm	F	£286.48
SL145R205-230	230 V, 50 Hz	3/4" BSPP	16.0 mm	G	£369.18
SL145R205-110	110 V, 50 Hz	3/4" BSPP	16.0 mm	G	£369.18
SL145R205-245	24 V, 50 Hz	3/4" BSPP	16.0 mm	G	£369.18
SL145R206-230	230 V, 50 Hz	1" BSPP	18.5 mm	G	£521.78
SL145R206-110	110 V, 50 Hz	1" BSPP	18.5 mm	G	£521.78
SL145R206-245	24 V, 50 Hz	1" BSPP	18.5 mm	G	£521.78

PILOT OPERATED NORMALLY CLOSED

DESCRIPTION

Diaphragm valve, pilot operated, having full orifice. Suitable to shut off liquid & gaseous fluids. 182 series not suitable for use with dangerous fluids.

SPECIFICATIONS	182 SERIES	182 SERIES
Functions	2/2 normally closed	
Min. differential pressure	0.35 bar	0.5 bar
Max. differential pressure	3/8" to 1/2": 16 bar 3/4" to 1": 12 bar	10 bar
Fluid temperature	-10°C to +140°C (14°F to 284°F)	-10°C to +90°C (14°F to 194°F)
Viscosity	5°E (37 cSt or mm ² /s)	
Voltage tolerance	+10% -15%	
Duty cycle	ED 100%	



5910

**PILOT OPERATED – 2/2 NC
182 SERIES**

PART NUMBER	VOLTAGE	PORT SIZE	ORIFICE SIZE	COIL TYPE	PRICE
SL182D0103-230	230 V, 50 Hz	3/8" BSPP	13.5 mm	B	£161.27
SL182D0103-110	110 V, 50 Hz	3/8" BSPP	13.5 mm	B	£161.27
SL182D0103-245	24 V, 50 Hz	3/8" BSPP	13.5 mm	B	£161.27
SL182D0103-24	24 V DC	3/8" BSPP	13.5 mm	B	£161.27
SL182D0104-230	230 V, 50 Hz	1/2" BSPP	13.5 mm	B	£152.15
SL182D0104-110	110 V, 50 Hz	1/2" BSPP	13.5 mm	B	£152.15
SL182D0104-245	24 V, 50 Hz	1/2" BSPP	13.5 mm	B	£152.15
SL182D0104-24	24 V DC	1/2" BSPP	13.5 mm	B	£152.15
SL182D0105-230	230 V, 50 Hz	3/4" BSPP	18.0 mm	B	£199.55
SL182D0105-110	110 V, 50 Hz	3/4" BSPP	18.0 mm	B	£199.55
SL182D0105-245	24 V, 50 Hz	3/4" BSPP	18.0 mm	B	£199.55
SL182D0105-24	24 V DC	3/4" BSPP	18.0 mm	B	£199.55
SL182D0106-230	230 V, 50 Hz	1" BSPP	24.0 mm	B	£301.05
SL182D0106-110	110 V, 50 Hz	1" BSPP	24.0 mm	B	£301.05
SL182D0106-245	24 V, 50 Hz	1" BSPP	24.0 mm	B	£301.05
SL182D0106-24	24 V DC	1" BSPP	24.0 mm	B	£301.05

MATERIALS

Body	Brass
Sealing	EDPM
Internal components	Brass & stainless steel
Seat	Brass
Core tube	Stainless steel
Shading coil	Copper

IP65 RATED

IP65 = dust tight; full protection & protection against directed water jets of low pressure (6.3 mm) from any angle this is only if the DIN plug (DIN43650/pg9) is correctly fitted to coil with the rubber seal in place.

Please note:
Other sealing
materials & coil
protection on
request



5910

**PILOT OPERATED – 2/2 NC
182 SERIES**

PART NUMBER	VOLTAGE	PORT SIZE	ORIFICE SIZE	COIL TYPE	PRICE
SL182B4808-230	230 V, 50 Hz	1 1/2" BSPP	45.0 mm	A	£743.34
SL182B4808-110	110 V, 50 Hz	1 1/2" BSPP	45.0 mm	A	£743.34
SL182B4808-245	24 V, 50 Hz	1 1/2" BSPP	45.0 mm	A	£743.34
SL182B4808-24	24 V DC	1 1/2" BSPP	45.0 mm	A	£743.34
SL182B4810-230	230 V, 50 Hz	2" BSPP	45.0 mm	A	£880.05
SL182B4810-110	110 V, 50 Hz	2" BSPP	45.0 mm	A	£880.05
SL182B4810-245	24 V, 50 Hz	2" BSPP	45.0 mm	A	£880.05
SL182B4810-24	24 V DC	2" BSPP	45.0 mm	A	£880.05

Do you also need?

PARKAIR®



Spare coils

Find it on page 455, section seven

PILOT OPERATED NORMALLY OPEN

DESCRIPTION

Diaphragm valve, pilot operated, having full orifice. Suitable to shut off liquid & gaseous fluids. Not suitable for use with dangerous fluids.

SPECIFICATIONS	282 SERIES	282 SERIES
	3/8" – 1"	1 1/2" – 2"
Functions	2/2 normally open	
Min. differential pressure	0.35 bar	0.5 bar
Max. differential pressure	12 bar	10 bar
Fluid temperature	-10°C to +90°C (14°F to 194°F)	
Viscosity	5°E (37 cSt or mm ² /s)	
Voltage tolerance	+10% -15%	DC +10% -5% AC +10% -15%
	Duty cycle ED 100%	

MATERIALS

Body	Brass
Sealing	NBR
Internal components	Brass & stainless steel
Seat	Brass
Core tube	Stainless steel
Shading coil	Copper

IP65 RATED

IP65 = dust tight; full protection & protection against directed water jets of low pressure (6.3 mm) from any angle this is only if the DIN plug (DIN43650/pg9) is correctly fitted to coil with the rubber seal in place.



5910



5910

PILOT OPERATED – 2/2 NO
282 SERIES

PART NUMBER	VOLTAGE	PORT SIZE	ORIFICE SIZE	COIL TYPE	PRICE
SL282B0103-230	230 V, 50 Hz	3/8" BSPP	13.5 mm	H	£209.18
SL282B0103-110	110 V, 50 Hz	3/8" BSPP	13.5 mm	H	£209.18
SL282B0103-245	24 V, 50 Hz	3/8" BSPP	13.5 mm	H	£209.18
SL282B0103-24	24 V DC	3/8" BSPP	13.5 mm	D	£209.18
SL282B0104-230	230 V, 50 Hz	1/2" BSPP	13.5 mm	H	£193.14
SL282B0104-110	110 V, 50 Hz	1/2" BSPP	13.5 mm	H	£193.14
SL282B0104-245	24 V, 50 Hz	1/2" BSPP	13.5 mm	H	£193.14
SL282B0104-24	24 V DC	1/2" BSPP	13.5 mm	D	£193.14
SL282B0105-230	230 V, 50 Hz	3/4" BSPP	18.0 mm	H	£244.98
SL282B0105-110	110 V, 50 Hz	3/4" BSPP	18.0 mm	H	£244.98
SL282B0105-245	24 V, 50 Hz	3/4" BSPP	18.0 mm	H	£244.98
SL282B0105-24	24 V DC	3/4" BSPP	18.0 mm	D	£244.98
SL282B0106-230	230 V, 50 Hz	1" BSPP	24.0 mm	H	£335.61
SL282B0106-110	110 V, 50 Hz	1" BSPP	24.0 mm	H	£335.61
SL282B0106-245	24 V, 50 Hz	1" BSPP	24.0 mm	H	£335.61
SL282B0106-24	24 V DC	1" BSPP	24.0 mm	K	£335.61

PILOT OPERATED – 2/2 NO
282 SERIES

PART NUMBER	VOLTAGE	PORT SIZE	ORIFICE SIZE	COIL TYPE	PRICE
SL282B4808-230	230 V, 50 Hz	1 1/2" BSPP	45.0 mm	J	£718.82
SL282B4808-110	110 V, 50 Hz	1 1/2" BSPP	45.0 mm	J	£718.82
SL282B4808-245	24 V, 50 Hz	1 1/2" BSPP	45.0 mm	J	£718.82
SL282B4808-24	24 V DC	1 1/2" BSPP	45.0 mm	A	£718.82
SL282B4810-230	230 V, 50 Hz	2" BSPP	45.0 mm	J	£776.85
SL282B4810-110	110 V, 50 Hz	2" BSPP	45.0 mm	J	£776.85
SL282B4810-245	24 V, 50 Hz	2" BSPP	45.0 mm	J	£776.85
SL282B4810-24	24 V DC	2" BSPP	45.0 mm	A	£776.85

Do you also need?

PARKAIR®



Spare coils

Find it on page 455, section seven

PILOT OPERATED NORMALLY CLOSED & NORMALLY OPEN

DESCRIPTION		
Diaphragm valve, pilot operated, having full orifice. Suitable to shut off liquid & gaseous fluids.		
SPECIFICATIONS		
	182 SERIES	282 SERIES
Functions	2/2 normally closed	2/2 normally open
Min. differential pressure	0.35 bar	0.35 bar
Max. differential pressure	16 bar – 3/8" to 1/2" 12 bar – 3/4" to 1"	12 bar
Fluid temperature	-10°C to +130°C (14°F to 266°F)	
Viscosity	5°E (37 cSt or mm ² /s)	
Voltage tolerance	DC +10% -5% AC +10% -15%	
Duty cycle	ED 100%	

MATERIALS	
Body	316 stainless steel
Sealing	FKM
Internal components	Stainless steel
Seat	316 stainless steel
Core tube	Stainless steel
Shading coil	Copper

IP65 RATED
IP65 = dust tight; full protection & protection against directed water jets of low pressure (6.3 mm) from any angle this is only if the DIN plug (DIN43650/pg9) is correctly fitted to coil with the rubber seal in place.



5910



5910

PILOT OPERATED – 2/2 NC 182 SERIES

PART NUMBER	VOLTAGE	PORT SIZE	ORIFICE SIZE	COIL TYPE	PRICE
SL182V0903-230	230 V, 50 Hz	3/8" BSPP	13.5 mm	C	£704.99
SL182V0903-110	110 V, 50 Hz	3/8" BSPP	13.5 mm	C	£704.99
SL182V0903-245	24 V, 50 Hz	3/8" BSPP	13.5 mm	C	£704.99
SL182V0903-24	24 V DC	3/8" BSPP	13.5 mm	C	£704.99
SL182V0904-230	230 V, 50 Hz	1/2" BSPP	13.5 mm	C	£730.91
SL182V0904-110	110 V, 50 Hz	1/2" BSPP	13.5 mm	C	£730.91
SL182V0904-245	24 V, 50 Hz	1/2" BSPP	13.5 mm	C	£730.91
SL182V0904-24	24 V DC	1/2" BSPP	13.5 mm	C	£730.91
SL182V0905-230	230 V, 50 Hz	3/4" BSPP	18.0 mm	C	£942.28
SL182V0905-110	110 V, 50 Hz	3/4" BSPP	18.0 mm	C	£942.28
SL182V0905-245	24 V, 50 Hz	3/4" BSPP	18.0 mm	C	£942.28
SL182V0905-24	24 V DC	3/4" BSPP	18.0 mm	C	£942.28
SL182V0906-230	230 V, 50 Hz	1" BSPP	24.0 mm	C	£1136.34
SL182V0906-110	110 V, 50 Hz	1" BSPP	24.0 mm	C	£1136.34
SL182V0906-245	24 V, 50 Hz	1" BSPP	24.0 mm	C	£1136.34
SL182V0906-24	24 V DC	1" BSPP	24.0 mm	C	£1136.34

PILOT OPERATED – 2/2 NO 282 SERIES

PART NUMBER	VOLTAGE	PORT SIZE	ORIFICE SIZE	COIL TYPE	PRICE
SL282V0903-230	230 V, 50 Hz	3/8" BSPP	13.5 mm	C	£715.36
SL282V0903-110	110 V, 50 Hz	3/8" BSPP	13.5 mm	C	£715.36
SL282V0903-245	24 V, 50 Hz	3/8" BSPP	13.5 mm	C	£715.36
SL282V0903-24	24 V DC	3/8" BSPP	13.5 mm	C	£715.36
SL282V0904-230	230 V, 50 Hz	1/2" BSPP	13.5 mm	C	£773.13
SL282V0904-110	110 V, 50 Hz	1/2" BSPP	13.5 mm	C	£773.13
SL282V0904-245	24 V, 50 Hz	1/2" BSPP	13.5 mm	C	£773.13
SL282V0904-24	24 V DC	1/2" BSPP	13.5 mm	C	£773.13
SL282V0905-230	230 V, 50 Hz	3/4" BSPP	18.0 mm	C	£922.26
SL282V0905-110	110 V, 50 Hz	3/4" BSPP	18.0 mm	C	£922.26
SL282V0905-245	24 V, 50 Hz	3/4" BSPP	18.0 mm	C	£922.26
SL282V0905-24	24 V DC	3/4" BSPP	18.0 mm	C	£922.26
SL282V0906-230	230 V, 50 Hz	1" BSPP	24.0 mm	C	£1175.37
SL282V0906-110	110 V, 50 Hz	1" BSPP	24.0 mm	C	£1175.37
SL282V0906-245	24 V, 50 Hz	1" BSPP	24.0 mm	C	£1175.37
SL282V0906-24	24 V DC	1" BSPP	24.0 mm	C	£1175.37

Do you also need?

PARKAIR® **Spare coils**

Find it on page 455, section seven

IP65 RATED COILS – FOR USE WITH STANDARD & STAINLESS STEEL SOLENOID VALVES

COILS
TYPE A



5920

PART NUMBER	POWER ABSORPTION			VOLTAGE	PRICE
	AC (VA)	DC			
	INRUSH	HOLDING	(W)		
SLZA30AA	23	14	-	230 V, 50 Hz	£49.08
SLZA30AC	23	14	-	110 V, 50 Hz	£49.08
SLZA30AE	23	14	-	24 V, 50 Hz	£49.08
SLZA30AL	-	-	9	24 V DC	£49.08

TYPE B

SLZB10AA	12	6	-	230 V, 50 Hz	£53.10
SLZB10AC	12	6	-	110 V, 50 Hz	£53.10
SLZB10AE	12	6	-	24 V, 50 Hz	£53.10
SLZB10AL	-	-	5.5	24 V DC	£53.10

TYPE C

SLZB12AA	12	6	-	230 V, 50 Hz	£56.16
SLZB12AC	12	6	-	110 V, 50 Hz	£56.16
SLZB12AE	12	6	-	24 V, 50 Hz	£56.16
SLZB12AL	-	-	5.5	24 V DC	£56.16

TYPE D

SLZ130AA	44	24	-	230 V, 50 Hz	£81.48
SLZ130AC	44	24	-	110 V, 50 Hz	£81.48
SLZ130AE	44	24	-	24 V, 50 Hz	£81.48
SLZ130AL	-	-	13	24 V DC	£81.48

TYPE E

SLZ923AA	50	27	-	230 V, 50 Hz	£114.51
SLZ923AC	50	27	-	110 V, 50 Hz	£114.51
SLZ923AE	50	27	-	24 V, 50 Hz	£114.51
SLZ923AL	-	-	17	24 V DC	£114.51

COILS
TYPE F



5920

PART NUMBER	POWER ABSORPTION			VOLTAGE	PRICE
	AC (VA)	DC			
	INRUSH	HOLDING	(W)		
SLZ614AA	16	10	-	230 V, 50 Hz	£56.79
SLZ614AC	16	10	-	110 V, 50 Hz	£56.79
SLZ614AE	16	10	-	24 V, 50 Hz	£56.79

TYPE G

SLZ534AA	23	14	-	230 V, 50 Hz	£82.11
SLZ534AC	23	14	-	110 V, 50 Hz	£82.11
SLZ534AE	23	14	-	24 V, 50 Hz	£82.11

TYPE H

SLZB10KAA	44	24	-	230 V, 50 Hz	£53.10
SLZB10KAC	44	24	-	110 V, 50 Hz	£53.10
SLZB10KAE	44	24	-	24 V, 50 Hz	£53.10

TYPE J

SLZA30YA	28	20	-	230 V, 50 Hz	£49.08
SLZA30YC	28	20	-	110 V, 50 Hz	£49.08
SLZA30YE	28	20	-	24 V, 50 Hz	£49.08

TYPE K

SLZB10YA	11.7	10	-	230 V, 50 Hz	£52.47
SLZB10YC	11.7	10	-	110 V, 50 Hz	£52.47
SLZB10YE	11.7	10	-	24 V, 50 Hz	£52.47
SLZC10AL	-	-	5.5	24 V DC	£43.53

OMAL VIP CO-AXIAL FLOW VALVES

BUNA SEALS



5910

VIP VALVE
DOUBLE ACTING

PART NUMBER	PORT SIZE	PRICE
SLVDA10003	3/8" BSP	£194.68
SLVDA10004	1/2" BSP	£221.96
SLVDA10005	3/4" BSP	£259.16
SLVDA10006	1" BSP	£290.16
SLVDA10007	1 1/4" BSP	£384.40
SLVDA10008	1 1/2" BSP	£478.64
SLVDA10009	2" BSP	£664.64

SPRING RETURN NORMALLY CLOSED

SLVNC10003	3/8" BSP	£205.84
SLVNC10004	1/2" BSP	£229.40
SLVNC10005	3/4" BSP	£272.80
SLVNC10006	1" BSP	£303.80
SLVNC10007	1 1/4" BSP	£411.68
SLVNC10008	1 1/2" BSP	£512.12
SLVNC10009	2" BSP	£708.04

SPRING RETURN NORMALLY OPEN

SLVNA10003	3/8" BSP	£205.84
SLVNA10004	1/2" BSP	£229.40
SLVNA10005	3/4" BSP	£272.80
SLVNA10006	1" BSP	£303.80
SLVNA10007	1 1/4" BSP	£411.68
SLVNA10008	1 1/2" BSP	£512.12
SLVNA10009	2" BSP	£708.04

VITON™ SEALS



5910

VIP VALVE
DOUBLE ACTING

PART NUMBER	PORT SIZE	PRICE
SLVDA20003	3/8" BSP	£207.08
SLVDA20004	1/2" BSP	£230.64
SLVDA20005	3/4" BSP	£274.04
SLVDA20006	1" BSP	£307.52
SLVDA20007	1 1/4" BSP	£410.44
SLVDA20008	1 1/2" BSP	£512.12
SLVDA20009	2" BSP	£703.08

SPRING RETURN NORMALLY CLOSED

SLVNC20003	3/8" BSP	£213.28
SLVNC20004	1/2" BSP	£241.80
SLVNC20005	3/4" BSP	£287.68
SLVNC20006	1" BSP	£323.64
SLVNC20007	1 1/4" BSP	£437.72
SLVNC20008	1 1/2" BSP	£545.60
SLVNC20009	2" BSP	£746.48

SPRING RETURN NORMALLY OPEN

SLVNA20003	3/8" BSP	£213.28
SLVNA20004	1/2" BSP	£241.80
SLVNA20005	3/4" BSP	£287.68
SLVNA20006	1" BSP	£323.64
SLVNA20007	1 1/4" BSP	£437.72
SLVNA20008	1 1/2" BSP	£545.60

DIRECT ACTING NORMALLY CLOSED

DESCRIPTION

Low cost direct acting solenoid valve for on-off control of non-aggressive fluids & gases, air, oil or water, compatible with materials of construction

SPECIFICATIONS

Functions	Normally closed, energised to open
Ambient temperature	-10°C to +55°C (14°F to 131°F)
Medium temperature	Max. 130°C (266°F)
Viscosity	Max. 21 cSt. 3°E
Coil voltage	12 V & 24 V DC, 24 V, 48 V, 110 V & 230 V 50 Hz
Voltage tolerance	± 10%
Consumption	DC: approx. 8 W
Duty cycle	100% continuous rating
Protection class	IP65 to DIN 40050 with correctly assembled connectors
Weight	0.20 kg
Coil insulation	Class F

MATERIALS

Body & tube	Brass
Other inner parts	Stainless steel
Seal	FKM

Max. Operating Pressure

8 Watt Coil E

	AC	DC
AVT1B17	0 to 30 bar	0 to 20 bar
AVT1B28	0 to 14 bar	0 to 10 bar
AVT2B28	0 to 14 bar	0 to 10 bar
AVT2B40	0 to 06 bar	0 to 03 bar

Kv measured in m³/h
Water at 1 bar pressure drop



9710

DIRECT ACTING – TYPE T NORMALLY CLOSED

PART NUMBER	PORT SIZE	ORIFICE SIZE	KV**	PRICE
AVT1B17	1/8"	1.7 mm	0.09 m ³ /h	£20.54
AVT1B28	1/8"	2.8 mm	0.21 m ³ /h	£20.54
AVT2B28	1/4"	2.8 mm	0.21 m ³ /h	£20.54
AVT2B40	1/4"	4.0 mm	0.30 m ³ /h	£20.54

Do you also need?



Solenoid coils

Find it on page 458, section seven

Coils to be ordered separately

DIRECT ACTING NORMALLY OPEN OR CLOSED

DESCRIPTION

Direct acting, two-way normally open or closed solenoid valve for on-off control of non-aggressive liquids & gases e.g. air, oil, water, compatible with materials of construction. Port sizes 1/8" to 1/2".

SPECIFICATIONS

Functions	2-way normally open or normally closed
Ambient temperature	-10°C to +55°C (14°F to 131°F)
Medium temperature	-10°C to +130°C (14°F to 266°F)
Viscosity	Max. 37 cSt. 5°E
Coil voltage	12 V & 24 V DC, 24 V, 48 V, 110 V & 230 V 50 Hz
Voltage tolerance	± 10% (+10% -5% on pure DC)
Response time	10 to 30 m/s
Duty cycle	100% continuous rating
Protection class	IP65 to DIN 40050 with correctly assembled connectors
Cycling frequencies	Max. 1500 cpm

MATERIALS

Body	Brass
Tube & nut	Stainless steel
Seal	FKM

Max. Operating Pressure

8 Watt Coil E

12 Watt Coil U

	AC	DC	AC	DC
AVA3K25	14 bar	9 bar	30 bar	25 bar
AVA2K30	10 bar	5 bar	25 bar	20 bar
AVA5K45	5 bar	2 bar	12 bar	7 bar
AVA8K45	5 bar	2 bar	12 bar	7 bar
AVA3Z25	14 bar	14 bar	17 bar	17 bar
AVA2Z30	10 bar	10 bar	15 bar	15 bar
AVA5Z45	4 bar	4 bar	6 bar	6 bar
AVA8Z45	4 bar	4 bar	6 bar	6 bar

Kv measured in m³/h
Water at 1 bar pressure drop

Coils to be ordered separately



9710

DIRECT ACTING – TYPE A NORMALLY CLOSED

PART NUMBER	PORT SIZE	ORIFICE SIZE	KV**	PRICE
AVA3K25	1/8"	2.5 mm	0.15 m ³ /h	£66.25
AVA2K30	1/4"	3.0 mm	0.18 m ³ /h	£66.25
AVA5K45	3/8"	4.5 mm	0.38 m ³ /h	£67.26
AVA8K45	1/2"	4.5 mm	0.54 m ³ /h	£72.41

NORMALLY OPEN

AVA3Z25	1/8"	2.5 mm	0.15 m ³ /h	£78.99
AVA2Z30	1/4"	3.0 mm	0.18 m ³ /h	£78.99
AVA5Z45	3/8"	4.5 mm	0.38 m ³ /h	£85.25
AVA8Z45	1/2"	4.5 mm	0.54 m ³ /h	£88.76

SERVO ASSISTED NORMALLY CLOSED / OPEN – BRASS

DESCRIPTION

Servo acting solenoid valves for on-off control of non-aggressive fluid, air, oil or water, compatible with materials of construction. Minimum pressure drop of 0.2 bar required to ensure satisfactory operation.

SPECIFICATIONS

Functions	Normally open or normally closed
Ambient temperature	-20°C to +55°C (-4°F to +131°F)
Medium temperature	-10°C to +130°C (14°F to 266°F)
Viscosity	Max. 37 cSt. 5°E
Coil voltage	12 V & 24 V DC, 24 V, 48 V, 110 V & 230 V 50 Hz
Voltage tolerance	± 10%
Consumption	DC 8 w
Duty cycle	100% continuous rating
Protection class	IP65 to DIN 40050 with correctly assembled connectors
Operating speed	Max. 200 cycles per min

MATERIALS

Body	Brass
Other inner parts	Stainless steel
Seal	FKM

Coils to be ordered separately

Max. Operating Pressure 8 Watt Coil E

AVW1K12	0.2 to 16 bar
AVW2K12	0.2 to 16 bar
AVW3K19	0.2 to 16 bar
AVW4K25	0.2 to 16 bar
AVW5K35	0.2 to 10 bar
AVW6K40	0.2 to 10 bar
AVW7K50	0.2 to 10 bar

Kv measured in m³/h
Water at 1 bar pressure drop



9710

SERVO ASSISTED – TYPE W NORMALLY CLOSED

PART NUMBER	PORT SIZE	ORIFICE SIZE	KV**	PRICE
AVW1K12	3/8"	13 mm	3.6 m ³ /h	£124.41
AVW2K12	1/2"	13 mm	4.2 m ³ /h	£131.87
AVW3K19	3/4"	19 mm	8.4 m ³ /h	£211.67
AVW4K25	1"	25 mm	11.0 m ³ /h	£230.85
AVW5K35	1 1/4"	35 mm	24.0 m ³ /h	£511.78
AVW6K40	1 1/2"	40 mm	31.0 m ³ /h	£541.81
AVW7K50	2"	50 mm	45.0 m ³ /h	£723.74

NORMALLY OPEN

AVW1Z12	3/8"	13 mm	3.6 m ³ /h	£152.57
AVW2Z12	1/2"	13 mm	4.2 m ³ /h	£159.95
AVW3Z19	3/4"	19 mm	8.4 m ³ /h	£237.43
AVW4Z25	1"	25 mm	11.0 m ³ /h	£258.60
AVW5Z35	1 1/4"	35 mm	24.0 m ³ /h	£529.88
AVW6Z40	1 1/2"	40 mm	31.0 m ³ /h	£552.81
AVW7Z50	2"	50 mm	45.0 m ³ /h	£751.89

Do you also need?



Solenoid coils

Find it on page 458, section seven

COMBINED OPERATION NORMALLY CLOSED – BRASS

DESCRIPTION

Solenoid valves type 21H are normally closed valves, energised to open & similar in design to servo acting valves 21W series but with the diaphragm coupled to the solenoid plunger. This enables the valve to operate at zero pressure without the need for a pressure differential, thus overcoming the problem associated with gravity feed & circulatory systems.

SPECIFICATIONS

Functions	Normally closed, energised to open
Ambient temperature	-20°C to +55°C (-4°F to +131°F)
Medium temperature	-10°C to +140°C (14°F to 284°F)
Viscosity	Max. 21 cSt. 3°E
Coil voltage	12 V & 24 V DC, 24 V, 48 V, 110 V & 230 V 50 Hz
Voltage tolerance	± 10%
Consumption	8 W 25/14 VA 12 W 35/25 14 W 43/27 VA
Duty cycle	100% continuous rating
Protection class	IP65 to DIN 400 with correctly assembled connectors

MATERIALS

Body	Brass
Seal	FKM

Max. Operating Pressure 8 Watt Coil E 12 Watt Coil U 14 Watt Coil M

	8 Watt Coil E		12 Watt Coil U		14 Watt Coil M	
	AC	DC	AC	DC	AC	DC
AVH1K-12	16 bar	1.5 bar	20 bar	6 bar	20 bar	15 bar
AVH2K-12	16 bar	1.5 bar	20 bar	6 bar	20 bar	15 bar
AV3HK-20	16 bar	6 bar	16 bar	16 bar	16 bar	16 bar
AVH4K-25	16 bar	5 bar	16 bar	16 bar	16 bar	16 bar
AVH8K-40	–	–	16 bar	0 bar	16 bar	6 bar

Kv measured in m³/h
Water at 1 bar pressure drop

Coils to be ordered separately



9710

COUPLED DIAPHRAGM – TYPE H NORMALLY CLOSED

PART NUMBER	PORT SIZE	ORIFICE SIZE	KV**	PRICE
AVH1K-12	3/8"	12 mm	1.7 m ³ /h	£135.93
AVH2K-12	1/2"	12 mm	1.9 m ³ /h	£150.44
AV3HK-20	3/4"	20 mm	7.2 m ³ /h	£179.53
AVH4K-25	1"	25 mm	8.4 m ³ /h	£201.45
AVH8K-40	1 1/2"	40 mm	16.8 m ³ /h	£523.12

COMBINED OPERATION NORMALLY CLOSED – STAINLESS STEEL

DESCRIPTION

Solenoid valves type 21IH are normally closed valves, energised to open & similar in design to servo acting valves 21W series but with the diaphragm coupled to the solenoid plunger. This enables the valve to operate at zero pressure without the need for a pressure differential, thus overcoming the problem associated with gravity feed & circulatory systems.

SPECIFICATIONS

Functions	Normally closed, energised to open
Ambient temperature	-20°C to +55°C (-4°F to +131°F)
Medium temperature	-10°C to +140°C (14°F to 284°F)
Viscosity	Max. 21 cSt. 3"E
Coil voltage	12 V & 24 V DC, 24 V, 48 V, 110 V & 230 V 50 Hz
Voltage tolerance	± 10%
Consumption	8 W 25/14 VA 12 W 35/25 14 W 43/27 VA
Duty cycle	100% continuous rating
Protection class	IP 65 EN 60529 (DIN 40050) with coil fitted by connector
MATERIALS	
Body	Stainless steel
Seal	FKM

**Kv measured in m³/h
Water at 1 bar pressure drop**

Max. Operating Pressure	8 Watt Coil E		12 Watt Coil U		14 Watt Coil M	
	AC	DC	AC	DC	AC	DC
AVH1K-15VSS	14 bar	6 bar	–	14 bar	–	–
AVH2K-16VSS	14 bar	6 bar	–	14 bar	–	–
AVH3K-20VSS	14 bar	6 bar	–	14 bar	–	–
AVH4K-25VSS	14 bar	3 bar	–	8 bar	14 bar	–
AVH5K-35VSS	–	–	–	–	14 bar	7 bar*
AVH6K-40VSS	–	–	–	–	14 bar	7 bar*

* Shading ring must be fitted (purchased separately)

Coils to be ordered separately

New



**COUPLED DIAPHRAGM – TYPE IH
NORMALLY CLOSED**

9710

PART NUMBER	PORT SIZE	ORIFICE SIZE	KV**	PRICE
AVH1K-15VSS	3/8"	15 mm	2.4 m ³ /h	£322.69
AVH2K-16VSS	1/2"	16 mm	3.0 m ³ /h	£341.69
AVH3K-20VSS	3/4"	20 mm	3.6 m ³ /h	£399.15
AVH4K-25VSS	1"	25 mm	8.4 m ³ /h	£552.27
AVH5K-35VSS	1 1/4"	35 mm	18.0 m ³ /h	£984.88
AVH6K-40VSS	1 1/2"	40 mm	19.2 m ³ /h	£1078.17

COILS FOR SOLENOID VALVES TYPES T, A, W, H & WA

COIL VOLTAGES					
12 V DC	24 V 50 Hz	110 V 50 Hz			
24 V DC	48 V 50 Hz	230 V 50 Hz			
Coil Consumption	E	H	U	M	L
Inrush current VA (AC)	25	25	35	43	15
Holding current VA (AC)	14	14	25	27	11
Power consumption W (AC/DC)	8	8	12	14	5



STANDARD

COIL TYPE E

FOR USE WITH

SOLENOID VALVE TYPE T, A, W & H

9710

PART NUMBER	TYPE	PRICE
AVA12VDCE	Standard	£31.93
AVA24VDCE	Standard	£31.93
AVA2450E	Standard	£31.93
AVA11050E	Standard	£31.93
AVA23050E	Standard	£32.66

For use with solenoid valve type T, A, W & H.

HIGH TEMPERATURE

COIL TYPE H

FOR USE WITH

SOLENOID VALVE TYPE A

9710

PART NUMBER	TYPE	PRICE
AVA12VDCH	High temperature	£35.80
AVA24VDCH	High temperature	£35.80
AVA2450H	High temperature	£35.80
AVA11050H	High temperature	£35.80
AVA23050H	High temperature	£35.80

For use with solenoid valve type A.

HIGH POWER

COIL TYPE U

FOR USE WITH

SOLENOID VALVE TYPE A

9710

PART NUMBER	TYPE	PRICE
AVA12VDCU	High power	£49.19
AVA24VDCU	High power	£49.19
AVA2450U	High power	£49.19
AVA11050U	High power	£49.19
AVA23050U	High power	£49.19

For use with solenoid valve type A.

COIL TYPE M

FOR USE WITH

SOLENOID VALVE TYPE H

9710

PART NUMBER	TYPE	PRICE
AVA24VDCM	High power	£76.31
AVA2450M	High power	£76.31
AVA11050M	High power	£76.31
AVA23050M	High power	£76.31

For use with solenoid valve type H.



Safety Valves

Safety valves are installed to release pressure immediately in case of an emergency or system failure. These valves protect equipment like pressure vessels and heat exchangers used in gas, vapour, or steam applications. Safety valves from reputed brands like Protect Air and Seetru are on the following pages.

Seetru offers a range of safety valves that are not only compact but highly efficient as well. These safety valves contain an exclusive seal technology that provides repeatable bubble-tight sealing performance. They are designed for various applications, including air/gas compressors, specialist gas plants, chemical equipment and piping, pressure vessels, thermal relief, medical gases, and more.

The safety relief valves come in bronze, brass, or stainless steel and feature a variety of connection options for temperatures up to 300°C.

Protect Air factory-preset pressure-reducing valves are suitable for air, oxygen, and water.

Protect air's pressure-reducing valves come with numerous benefits:

- Protection of your application against pressure manipulation
- Shortening of installation time due to factory presetting
- Increased safety and energy efficiency
- Reduction of your compressed air consumption and thus your costs
- Ensures safety of both workforce and machinery
- Can help extend the lifespan of your equipment



HOSEGUARD® AIR FUSES

APPLICATIONS

- Suitable for every application where compressed air is used
- Cleanrooms
- Offshore
- Medical industries

FEATURES / BENEFITS

- Protects personnel, machinery, & plant
- Maintenance friendly – repair possible while plant is still working
- Economic: competitive pricing, no unnecessary repairs
- Complies with EN ISO 4414/ISO 4414 5.4.5.11.1 machine directive 2006/42/EG
- MSHA (Mine Safety & Health Administration) Regulations: 30 CFR Sections 56.13021 high pressure hose connection states: 30 CFR sections 57.1730. Compressed air, general, compressed air systems.
- Reliable & tamper proof, no adjustment necessary
- Lightweight – compact size
- Compatible with all pneumatic systems
- Can be used as a flow blocker if ordered as 'No reset' – contact your distributor for further details
- CE marked
- EU Registered Utility Model No. 0025 73 525
- USA/US Design Patent D 475,126

SPECIFICATIONS

Temperature - 1/4" – 1/2"	-20°C to +80°C (-4°F to +176°F)
3/4" – 2"	-20°C to +120°C (-4°F to +248°F)
Max. pressure	18 bar (261 psi)
Media	Compressed air
Pressure loss	0.05 to 0.1 bar (0.7 to 1.5 psi)
Pressure loss by closing	0.3 bar (5 psi)
Applicable standards	2011/65/EU – CE RoHS 2012/19/EU – WEEE 1907/2006/EU – REACH

MATERIALS

Housing	Stainless steel or aluminium
Other parts	NBR, POM, stainless steel, aluminium

For technical data, please visit our literature section online



HOSEGUARD® AIR FUSE BSPP MALE / BSPP FEMALE

PART NUMBER	THREAD	MAX. PRESSURE	FLOW AT 8 BAR	PRICE
PA281A0221	1/4" BSPP	18 bar	760 NI/min	£57.63
PA281A0321	3/8" BSPP	18 bar	1080 NI/min	£76.38
PA281A0421	1/2" BSPP	18 bar	3020 NI/min	£89.65

LOW FLOW

PA281ZL0221	1/4" BSPP	18 bar	52 NI/min	£60.38
-------------	-----------	--------	-----------	--------

HIGH FLOW

PA281ZH0221	1/4" BSPP	18 bar	990 NI/min	£71.81
PA281ZH0321	3/8" BSPP	18 bar	1450 NI/min	£95.59
PA281ZH0421	1/2" BSPP	18 bar	3440 NI/min	£112.06

HOSEGUARD® STAINLESS STEEL AIR FUSE BSPP MALE / BSPP FEMALE HIGH FLOW



5100

PART NUMBER	THREAD	MAX. PRESSURE	FLOW AT 8 BAR	PRICE
PA281RZH0221	1/4" BSPP	18 bar	990 NI/min	£286.78
PA281RZH0421	1/2" BSPP	18 bar	3440 NI/min	£308.73

HOSEGUARD® STAINLESS STEEL AIR FUSE BSPP FEMALE



5100

PART NUMBER	THREAD	MAX. PRESSURE	FLOW AT 8 BAR	PRICE
PA281RZ0211	1/4" BSPP	18 bar	990 NI/min	£214.05
PA281RZ0411	1/2" BSPP	18 bar	3440 NI/min	£223.66

HOSEGUARD® AIR FUSE BSPP FEMALE



5100

PART NUMBER	THREAD	MAX. PRESSURE	FLOW AT 8 BAR	PRICE
PA281A0211	1/4" BSPP	18 bar	760 NI/min	£55.80
PA281A0311	3/8" BSPP	18 bar	1080 NI/min	£74.10
PA281A0411	1/2" BSPP	18 bar	3020 NI/min	£86.90
PA281A0511	3/4" BSPP	18 bar	4070 NI/min	£129.93
PA281A0611	1" BSPP	18 bar	5220 NI/min	£205.82

LOW FLOW

PA281ZL0211	1/4" BSPP	18 bar	52 NI/min	£59.00
-------------	-----------	--------	-----------	--------

HIGH FLOW

PA281ZH0211	1/4" BSPP	18 bar	990 NI/min	£69.98
PA281ZH0311	3/8" BSPP	18 bar	1450 NI/min	£92.39
PA281ZH0411	1/2" BSPP	18 bar	3440 NI/min	£108.85
PA281ZH0511	3/4" BSPP	18 bar	5250 NI/min	£135.52
PA281ZH0611	1" BSPP	18 bar	7600 NI/min	£231.23

NPT threads & larger sizes available upon request

IN-LINE PRESET REGULATORS

DESCRIPTION

New standards have lowered the acceptable lead concentration in food & beverage regulators from 25 mg/L to 5 mg/L or lower. The new EcoReg® in-line regulator is NSF 61 & 372 certified & is entirely lead free & therefore recommended for any food or beverage application.

APPLICATIONS

- Coffee machines
- Dental industry
- Drinking water
- Food industry
- Medical industry
- Vending machines

FEATURES / BENEFITS

- Factory pressure presetting
- Reduces consumption
- Reliability
- Service free – no adjustment needed
- Tamper proof
- Lightweight – compact construction
- Easy to mount in any water supply system
- Extension by sprinkler equipment
- In compliance with NSF / FDA regulations

SPECIFICATIONS

Temperature	Water: 4°C to 60°C (39°F to 140°F) Other gases: 0°C to 60°C (32°F to 140°F)
Max. inlet pressure	Water: 15 bar (217 psi) Other gases: 18 bar (260 psi)
Media	Water & other fluids
Variation in pre-set pressure	1 to 3 bar: +/-0.3 bar (4.35 psi) at 10 l/min 3.5 to 8 bar: +/-10%
Applicable standards	2011/65/EU – CE RoHS 2012/19/EU – WEEE 1907/2006/EU – REACH

MATERIALS

Housing	Grivory® GV-5 FWA
Spindle	DIN 1.4404 / 316L stainless steel
Diaphragm	EPDM
Spring	DIN 1.4310 / 301 stainless steel
Valve seat	PPH

For technical data, please visit our literature section online

DESCRIPTION

The OxyReg® pressure regulator ensures a constant output pressure. An independent diaphragm, lead free regulator, it has been preset by the factory, which reduces the cost of wasted oxygen due to overpressure.

APPLICATIONS

- Anaesthetic equipment
- Respiratory equipment
- Nitrogen filled systems
- Food & drink preservation equipment

FEATURES / BENEFITS

- High quality materials
- Factory preset pressure
- Service free – no adjustment needed
- Tamper proof
- No pressure gauge needed
- Lightweight – compact, in-line construction
- Saves energy – reduces costs
- Highly reliable
- Locked to prevent pressure change – tamper proof

SPECIFICATIONS

Temperature	4°C to 60°C (39°F to 140°F)
Max. inlet pressure	18 bar (261 psi)
Media	Oxygen & other inert gases, such as nitrogen, argon etc
Outlet pressure (pre-set)	1 to 8 bar (14.5 to 116 psi)
Applicable standards	2011/65/EU – CE RoHS 2012/19/EU – WEEE 1907/2006/EU – REACH

MATERIALS

Housing	Grivory® GV-5 FWA
Other parts	Stainless steel

For technical data, please visit our literature section online



5100

Ecoreg® IN-LINE REGULATOR FOR DRINKING WATER & OTHER FLUIDS BSPP FEMALE

PART NUMBER	THREAD	PRE-SET PRESSURE	PRICE
PA239K0210	1/4" BSPP	1.0 bar	£85.07
PA239K0215	1/4" BSPP	1.5 bar	£89.19
PA239K0220	1/4" BSPP	2.0 bar	£85.07
PA239K0225	1/4" BSPP	2.5 bar	£89.19
PA239K0230	1/4" BSPP	3.0 bar	£85.07
PA239K0235	1/4" BSPP	3.5 bar	£89.19
PA239K0240	1/4" BSPP	4.0 bar	£85.07
PA239K0245	1/4" BSPP	4.5 bar	£89.19
PA239K0250	1/4" BSPP	5.0 bar	£85.07
PA239K0255	1/4" BSPP	5.5 bar	£89.19
PA239K0260	1/4" BSPP	6.0 bar	£85.07
PA239K0265	1/4" BSPP	6.5 bar	£89.19
PA239K0270	1/4" BSPP	7.0 bar	£85.07
PA239K0280	1/4" BSPP	8.0 bar	£85.07



5100

Oxyreg® IN-LINE REGULATOR PRESET REGULATOR FOR OXYGEN BSPP FEMALE

PART NUMBER	THREAD	PRE-SET PRESSURE	PRICE
PA234KM0210	1/4" BSPP	1.0 bar	£111.17
PA234KM0215	1/4" BSPP	1.5 bar	£111.17
PA234KM0220	1/4" BSPP	2.0 bar	£111.17
PA234KM0225	1/4" BSPP	2.5 bar	£111.17
PA234KM0230	1/4" BSPP	3.0 bar	£111.17
PA234KM0235	1/4" BSPP	3.5 bar	£111.17
PA234KM0240	1/4" BSPP	4.0 bar	£111.17
PA234KM0245	1/4" BSPP	4.5 bar	£111.17
PA234KM0250	1/4" BSPP	5.0 bar	£111.17
PA234KM0255	1/4" BSPP	5.5 bar	£111.17
PA234KM0260	1/4" BSPP	6.0 bar	£111.17
PA234KM0265	1/4" BSPP	6.5 bar	£111.17
PA234KM0270	1/4" BSPP	7.0 bar	£111.17
PA234KM0280	1/4" BSPP	8.0 bar	£111.17



Did you know?

Products with safety benefits are indicated by a chevron at the bottom of their table

IN-LINE PRESET REGULATORS

APPLICATIONS

- Piping & compressed air systems
- Compressed air used in automation for actuation
- Control, feeding or transportation
- 'Pick & Place' units in automatic assembly systems

FEATURES / BENEFITS

- Supplies tools exclusively with the specified pressure
- No pressure gauge needed
- Prevents compressed air waste
- Saves energy – reduces cost
- Highly reliable
- Tamper proof
- Locked to prevent pressure change
- Small & compact
- Increases tool service life

SPECIFICATIONS

Temperature	Other gases 0°C to 60°C (32°F to 140°F)
Max. inlet pressure	18 bar (255 psi)
Media	Compressed air
Variation in pre-set pressure	1 to 3.5 bar: +/-0.3 bar – at 10 l/min 4 to 8 bar: +/-10%
Applicable standards	2011/65/EU – CE RoHS 2012/19/EU – WEEE 1907/2006/EU – REACH

MATERIALS

Housing	Zinc
Other parts	Brass, NBR, stainless steel

For technical data, please visit our literature section online



5100

SAVEAIR® IN-LINE REGULATOR FOR COMPRESSED AIR BSPP FEMALE

PART NUMBER	THREAD	PRE-SET PRESSURE	PRICE
PA231A010	1/4" BSPP	1.0 bar	£48.48
PA231A020	1/4" BSPP	2.0 bar	£48.48
PA231A030	1/4" BSPP	3.0 bar	£48.48
PA231A040	1/4" BSPP	4.0 bar	£48.48
PA231A050	1/4" BSPP	5.0 bar	£48.48
PA231A060	1/4" BSPP	6.0 bar	£48.48
PA231A065	1/4" BSPP	6.5 bar	£51.23
PA231A070	1/4" BSPP	7.0 bar	£48.48
PA231A080	1/4" BSPP	8.0 bar	£48.48

APPLICATIONS

- Pneumatic blow guns
- Pneumatic tools
- 'Pick & Place' units & automatic assembly lines

FEATURES / BENEFITS

- Safety: protects personnel, machinery & plant by avoiding pressure surges
- Ensures optimal air tool efficiency by supplying a constant pre-set pressure
- Prevents compressed air waste – limits excessive compressed air consumption = reducing energy costs
- Easy assembly: can be integrated into any 1/4" pneumatic tool
- Lightweight (15 g) & compact (hexagon 14 mm, length 24 mm)
- Locked to prevent pressure change – tamper proof
- Competitively priced
- Increases tool service life

SPECIFICATIONS

Temperature	-20°C to +60°C (-4°F to +140°F)
Max. inlet pressure	12 bar (174 psi)
Media	Compressed air
Flow	350 l/min
Applicable standards	2011/65/EU – CE RoHS 2012/19/EU – WEEE 1907/2006/EU – REACH

MATERIALS

Housing & piston	Brass
Spring	Stainless steel
O-rings	NBR

For technical data, please visit our literature section online



5100

CARTREG® MINIATURE IN-LINE PRESET REGULATOR FOR BLOW GUNS & PNEUMATIC TOOLS BSPP MALE / BSPP FEMALE

PART NUMBER	THREAD	PRE-SET PRESSURE	PRICE
PA233F0220	1/4" BSPP	2 bar	£25.41
PA233F0230	1/4" BSPP	3 bar	£25.41
PA233F0240	1/4" BSPP	4 bar	£25.41
PA233F0260	1/4" BSPP	6 bar	£25.41
PA233F0280	1/4" BSPP	8 bar	£25.41



Did you know?

Products with safety benefits are indicated by a chevron at the bottom of their table



Do you also need?



Pipe sealant



Find it on page 921, section fifteen

IN-LINE PRESET REGULATOR WITH SECONDARY PRESSURE RELIEF

APPLICATIONS

- Avoid costly overpressure in tools
- In situations where small amounts of compressed air are required, but pressure & flow must be stringently regulated
- Pneumatic tools – particularly nailers, tackers, etc.
- Furniture, construction & precision engineering trades
- Piping & compressed air systems
- Compressed air used in automation for actuation
- Control, feeding & transportation

FEATURES / BENEFITS

- Automatic secondary pressure relief
- Corrosion resistant
- High flow performance (0 – 4600 l/min / 0 – 105 SCFM)
- High pressure performance (inlet pressure up to 25 bar / 355 psi)
- Highly reliable
- Increases tool service life
- Locked to prevent pressure change – tamper proof
- Lightweight – small & compact size
- No pressure gauge needed
- Prevents compressed air waste
- Protection guaranteed – no residual pressure in tool
- Supplies tools exclusively with the specified pressure
- Saves energy – reduces costs

SPECIFICATIONS

Temperature	0°C to 80°C (32°F to 176°F)
Max. inlet pressure	25 bar (363 psi)
Media	Compressed air
Flow	0 – 4600 l/min / 0 – 105 SCFM
Applicable standards	2011/65/EU – CE RoHS 2012/19/EU – WEEE 1907/2006/EU – REACH

MATERIALS

Housing	Aluminium
Other parts	Stainless steel, NBR, brass, PPH

For technical data, please visit our literature section online



Did you know?

Products with safety benefits are indicated by a chevron at the bottom of their table

NPT available upon request



5100

TOOLREG® WITH AUTOMATIC SECONDARY PRESSURE RELIEF BSPP MALE / BSPP FEMALE

PART NUMBER	THREAD	PRE-SET PRESSURE	PRICE
PA232F0220	1/4" BSPP	2 bar	£67.76
PA232F0230	1/4" BSPP	3 bar	£67.76
PA232F0240	1/4" BSPP	4 bar	£67.76
PA232F0250	1/4" BSPP	5 bar	£67.76
PA232F0260	1/4" BSPP	6 bar	£67.76
PA232F0270	1/4" BSPP	7 bar	£67.76
PA232F0280	1/4" BSPP	8 bar	£67.76



5100

TOOLREG® WITH AUTOMATIC SECONDARY PRESSURE RELIEF BSPP FEMALE

PART NUMBER	THREAD	PRE-SET PRESSURE	PRICE
PA232A0220	1/4" BSPP	2 bar	£67.76
PA232A0230	1/4" BSPP	3 bar	£67.76
PA232A0240	1/4" BSPP	4 bar	£67.76
PA232A0250	1/4" BSPP	5 bar	£67.76
PA232A0260	1/4" BSPP	6 bar	£67.76
PA232A0270	1/4" BSPP	7 bar	POA
PA232A0280	1/4" BSPP	8 bar	£67.76
PA232A0320	3/8" BSPP	2 bar	£92.11
PA232A0330	3/8" BSPP	3 bar	£92.11
PA232A0340	3/8" BSPP	4 bar	£92.11
PA232A0350	3/8" BSPP	5 bar	£92.11
PA232A0360	3/8" BSPP	6 bar	£92.11
PA232A0380	3/8" BSPP	8 bar	£92.11
PA232A0420	1/2" BSPP	2 bar	£101.64
PA232A0430	1/2" BSPP	3 bar	£101.64
PA232A0440	1/2" BSPP	4 bar	£101.64
PA232A0450	1/2" BSPP	5 bar	£101.64
PA232A0460	1/2" BSPP	6 bar	£101.64
PA232A0480	1/2" BSPP	8 bar	£101.64
PA232A0520	3/4" BSPP	2 bar	£275.28
PA232A0530	3/4" BSPP	3 bar	POA
PA232A0540	3/4" BSPP	4 bar	£275.28
PA232A0550	3/4" BSPP	5 bar	POA
PA232A0560	3/4" BSPP	6 bar	£275.28
PA232A0580	3/4" BSPP	8 bar	£275.28

FEATURES

Atmospheric discharge valves for compressed air or gas. These valves offer repeatable bubble-tight sealing performance. Designed for applications including: air / gas compressors & air receivers.

The valves are CE & UKCA marked, TUV approved & designed in accordance with ISO 4126-1.

All Seetru safety valves are supplied with a PED & UKCA declaration of test & conformity certificate.

Most common pressures shown below, others available upon request.

SPECIFICATIONS

Body material	Brass
Seal material	FKM
Temperature range	-15°C to +200°C
Spring	Stainless steel

Valves are supplied with rota-lift manual easing gear

81806 SERIES 6 MM BORE



2270

PART NUMBER	INLET	PRESSURE	PRICE
SET-818061223-6.0	1/4" BSPT	6.0 bar	£53.04
SET-818061223-6.5	1/4" BSPT	6.5 bar	£53.04
SET-818061223-7.0	1/4" BSPT	7.0 bar	£53.04
SET-818061223-7.5	1/4" BSPT	7.5 bar	£53.04
SET-818061223-8.0	1/4" BSPT	8.0 bar	£53.04
SET-818061223-8.5	1/4" BSPT	8.5 bar	£53.04
SET-818061223-9.0	1/4" BSPT	9.0 bar	£53.04
SET-818061223-9.5	1/4" BSPT	9.5 bar	£53.04
SET-818061223-10.0	1/4" BSPT	10.0 bar	£53.04
SET-818061223-10.5	1/4" BSPT	10.5 bar	£53.04
SET-818061223-11.0	1/4" BSPT	11.0 bar	£53.04
SET-818061223-11.5	1/4" BSPT	11.5 bar	£53.04
SET-818061223-12.0	1/4" BSPT	12.0 bar	£53.04
SET-818061223-12.5	1/4" BSPT	12.5 bar	£53.04
SET-818061223-13.0	1/4" BSPT	13.0 bar	£53.04
SET-818061223-13.5	1/4" BSPT	13.5 bar	£53.04
SET-818061223-14.0	1/4" BSPT	14.0 bar	£53.04
SET-818061223-14.5	1/4" BSPT	14.5 bar	£53.04
SET-818061223-15.0	1/4" BSPT	15.0 bar	£53.04

81888 SERIES 8 MM BORE



2270

PART NUMBER	INLET	PRESSURE	PRICE
SET-818881223-6.0	1/4" BSPT	6.0 bar	£76.02
SET-818881223-6.5	1/4" BSPT	6.5 bar	£76.02
SET-818881223-7.0	1/4" BSPT	7.0 bar	£76.02
SET-818881223-7.5	1/4" BSPT	7.5 bar	£76.02
SET-818881223-8.0	1/4" BSPT	8.0 bar	£76.02
SET-818881223-8.5	1/4" BSPT	8.5 bar	£76.02
SET-818881223-9.0	1/4" BSPT	9.0 bar	£76.02
SET-818881223-9.5	1/4" BSPT	9.5 bar	£76.02
SET-818881223-10.0	1/4" BSPT	10.0 bar	£76.02
SET-818881223-10.5	1/4" BSPT	10.5 bar	£76.02
SET-818881223-11.0	1/4" BSPT	11.0 bar	£76.02
SET-818881223-11.5	1/4" BSPT	11.5 bar	£76.02
SET-818881223-12.0	1/4" BSPT	12.0 bar	£76.02
SET-818881223-12.5	1/4" BSPT	12.5 bar	£76.02
SET-818881223-13.0	1/4" BSPT	13.0 bar	£76.02
SET-818881223-13.5	1/4" BSPT	13.5 bar	£76.02
SET-818881223-14.0	1/4" BSPT	14.0 bar	£76.02
SET-818881223-14.5	1/4" BSPT	14.5 bar	£76.02
SET-818881223-15.0	1/4" BSPT	15.0 bar	£76.02

81888 SERIES 8 MM BORE



2270

PART NUMBER	INLET	PRESSURE	PRICE
SET-818881283-6.0	1/2" BSPT	6.0 bar	£76.02
SET-818881283-6.5	1/2" BSPT	6.5 bar	£76.02
SET-818881283-7.0	1/2" BSPT	7.0 bar	£76.02
SET-818881283-7.5	1/2" BSPT	7.5 bar	£76.02
SET-818881283-8.0	1/2" BSPT	8.0 bar	£76.02
SET-818881283-8.5	1/2" BSPT	8.5 bar	£76.02
SET-818881283-9.0	1/2" BSPT	9.0 bar	£76.02
SET-818881283-9.5	1/2" BSPT	9.5 bar	£76.02
SET-818881283-10.0	1/2" BSPT	10.0 bar	£76.02
SET-818881283-10.5	1/2" BSPT	10.5 bar	£76.02
SET-818881283-11.0	1/2" BSPT	11.0 bar	£76.02
SET-818881283-11.5	1/2" BSPT	11.5 bar	£76.02
SET-818881283-12.0	1/2" BSPT	12.0 bar	£76.02
SET-818881283-12.5	1/2" BSPT	12.5 bar	£76.02
SET-818881283-13.0	1/2" BSPT	13.0 bar	£76.02
SET-818881283-13.5	1/2" BSPT	13.5 bar	£76.02
SET-818881283-14.0	1/2" BSPT	14.0 bar	£76.02
SET-818881283-14.5	1/2" BSPT	14.5 bar	£76.02
SET-818881283-15.0	1/2" BSPT	15.0 bar	£76.02



Did you know?

Products with safety benefits are indicated by a chevron at the bottom of their table

FEATURES

- The Seetru LGS™ multi purpose pressure relief valve is a high quality, repeatable relief valve
- The robust & reliable construction of the Seetru LGS™ valve range is designed for the widest range of industrial applications
- Single trim design means that the valves can be used for liquid, gas or steam applications, including hot water boilers & air receivers
- The valves are CE & UKCA marked, TUV approved & designed in accordance with ISO 4126-1
- All Seetru safety valves are supplied with a PED & UKCA declaration of test & conformity certificate
- Most common pressures shown below, others available upon request
- WRAS approved product – compliant with the requirements of the United Kingdom Water Supply (Water Fittings) Regulations & Scottish Water Byelaws
- Supplied with test certificates

SPECIFICATIONS

Body material	Bronze
Inlet material	Brass
Spring material	Stainless steel
Seal material	PTFE
Valves are supplied with lever lift manual easing gear	
Temperature range	-60°C to +200°C
Set pressure	0.2 bar (g) to 24 bar (g)

All Seetru pressure relief valves are supplied with test certificates



MULTI PURPOSE PRESSURE RELIEF VALVES



2275



2275

LGS™ BRONZE SAFETY VALVES DN 15 MM

PART NUMBER	INLET / OUTLET	PRESSURE	PRICE
SET-L3615A3277-0.5	1/2" BSPP	0.5 bar	£189.63
SET-L3615A3277-1.0	1/2" BSPP	1.0 bar	£189.63
SET-L3615A3277-1.5	1/2" BSPP	1.5 bar	£189.63
SET-L3615A3277-2.0	1/2" BSPP	2.0 bar	£189.63
SET-L3615A3277-2.5	1/2" BSPP	2.5 bar	£189.63
SET-L3615A3277-3.0	1/2" BSPP	3.0 bar	£189.63
SET-L3615A3277-3.5	1/2" BSPP	3.5 bar	£189.63
SET-L3615A3277-4.0	1/2" BSPP	4.0 bar	£189.63
SET-L3615A3277-4.5	1/2" BSPP	4.5 bar	£189.63
SET-L3615A3277-5.0	1/2" BSPP	5.0 bar	£189.63
SET-L3615A3277-5.5	1/2" BSPP	5.5 bar	£189.63
SET-L3615A3277-6.0	1/2" BSPP	6.0 bar	£189.63
SET-L3615A3277-6.5	1/2" BSPP	6.5 bar	£189.63
SET-L3615A3277-7.0	1/2" BSPP	7.0 bar	£189.63
SET-L3615A3277-7.5	1/2" BSPP	7.5 bar	£189.63
SET-L3615A3277-8.0	1/2" BSPP	8.0 bar	£189.63
SET-L3615A3277-8.5	1/2" BSPP	8.5 bar	£189.63
SET-L3615A3277-9.0	1/2" BSPP	9.0 bar	£189.63
SET-L3615A3277-9.5	1/2" BSPP	9.5 bar	£189.63
SET-L3615A3277-10.0	1/2" BSPP	10.0 bar	£189.63
SET-L3615A3277-10.5	1/2" BSPP	10.5 bar	£189.63
SET-L3615A3277-11.0	1/2" BSPP	11.0 bar	£189.63
SET-L3615A3277-11.5	1/2" BSPP	11.5 bar	£189.63
SET-L3615A3277-12.0	1/2" BSPP	12.0 bar	£189.63
SET-L3615A3277-12.5	1/2" BSPP	12.5 bar	£189.63
SET-L3615A3277-13.0	1/2" BSPP	13.0 bar	£189.63
SET-L3615A3277-13.5	1/2" BSPP	13.5 bar	£189.63
SET-L3615A3277-14.0	1/2" BSPP	14.0 bar	£189.63
SET-L3615A3277-14.5	1/2" BSPP	14.5 bar	£189.63
SET-L3615A3277-15.0	1/2" BSPP	15.0 bar	£189.63

LGS™ BRONZE SAFETY VALVES DN 20 MM

PART NUMBER	INLET / OUTLET	PRESSURE	PRICE
SET-L3620A3307-0.5	3/4" BSPP	0.5 bar	£198.06
SET-L3620A3307-1.0	3/4" BSPP	1.0 bar	£198.06
SET-L3620A3307-1.5	3/4" BSPP	1.5 bar	£198.06
SET-L3620A3307-2.0	3/4" BSPP	2.0 bar	£198.06
SET-L3620A3307-2.5	3/4" BSPP	2.5 bar	£198.06
SET-L3620A3307-3.0	3/4" BSPP	3.0 bar	£198.06
SET-L3620A3307-3.5	3/4" BSPP	3.5 bar	£198.06
SET-L3620A3307-4.0	3/4" BSPP	4.0 bar	£198.06
SET-L3620A3307-4.5	3/4" BSPP	4.5 bar	£198.06
SET-L3620A3307-5.0	3/4" BSPP	5.0 bar	£198.06
SET-L3620A3307-5.5	3/4" BSPP	5.5 bar	£198.06
SET-L3620A3307-6.0	3/4" BSPP	6.0 bar	£198.06
SET-L3620A3307-6.5	3/4" BSPP	6.5 bar	£198.06
SET-L3620A3307-7.0	3/4" BSPP	7.0 bar	£198.06
SET-L3620A3307-7.5	3/4" BSPP	7.5 bar	£198.06
SET-L3620A3307-8.0	3/4" BSPP	8.0 bar	£198.06
SET-L3620A3307-8.5	3/4" BSPP	8.5 bar	£198.06
SET-L3620A3307-9.0	3/4" BSPP	9.0 bar	£198.06
SET-L3620A3307-9.5	3/4" BSPP	9.5 bar	£198.06
SET-L3620A3307-10.0	3/4" BSPP	10.0 bar	£198.06
SET-L3620A3307-10.5	3/4" BSPP	10.5 bar	£198.06
SET-L3620A3307-11.0	3/4" BSPP	11.0 bar	£198.06
SET-L3620A3307-11.5	3/4" BSPP	11.5 bar	£198.06
SET-L3620A3307-12.0	3/4" BSPP	12.0 bar	£198.06
SET-L3620A3307-12.5	3/4" BSPP	12.5 bar	£198.06
SET-L3620A3307-13.0	3/4" BSPP	13.0 bar	£198.06
SET-L3620A3307-13.5	3/4" BSPP	13.5 bar	£198.06
SET-L3620A3307-14.0	3/4" BSPP	14.0 bar	£198.06
SET-L3620A3307-14.5	3/4" BSPP	14.5 bar	£198.06
SET-L3620A3307-15.0	3/4" BSPP	15.0 bar	£198.06

FEATURES

- The Seetru LGS™ multi purpose pressure relief valve is a high quality, repeatable relief valve
- The robust & reliable construction of the Seetru LGS™ valve range is designed for the widest range of industrial applications
- Single trim design means that the valves can be used for liquid, gas or steam applications including hot water boilers & air receivers
- The valves are CE & UKCA marked, TUV approved & designed in accordance with ISO 4126-1
- All Seetru safety valves are supplied with a PED & UKCA declaration of test & conformity certificate
- Most common pressures shown below, others available upon request
- WRAS approved product – compliant with the requirements of the United Kingdom Water Supply (Water Fittings) Regulations & Scottish Water Byelaws
- Supplied with test certificates

SPECIFICATIONS

Body material	Bronze
Inlet material	Brass
Spring material	Stainless steel
Seal material	PTFE
Valves are supplied with lever lift manual easing gear	
Temperature range	-60°C to + 200°C
Set pressure	0.2 bar (g) to 24 bar (g)

All Seetru pressure relief valves are supplied with test certificates



MULTI PURPOSE PRESSURE RELIEF VALVES



2275



2275

LGS™ BRONZE SAFETY VALVES DN 25 MM

PART NUMBER	INLET / OUTLET	PRESSURE	PRICE
SET-L3625A3337-0.5	1" BSPP	0.5 bar	£248.82
SET-L3625A3337-1.0	1" BSPP	1.0 bar	£248.82
SET-L3625A3337-1.5	1" BSPP	1.5 bar	£248.82
SET-L3625A3337-2.0	1" BSPP	2.0 bar	£248.82
SET-L3625A3337-2.5	1" BSPP	2.5 bar	£248.82
SET-L3625A3337-3.0	1" BSPP	3.0 bar	£248.82
SET-L3625A3337-3.5	1" BSPP	3.5 bar	£248.82
SET-L3625A3337-4.0	1" BSPP	4.0 bar	£248.82
SET-L3625A3337-4.5	1" BSPP	4.5 bar	£248.82
SET-L3625A3337-5.0	1" BSPP	5.0 bar	£248.82
SET-L3625A3337-5.5	1" BSPP	5.5 bar	£248.82
SET-L3625A3337-6.0	1" BSPP	6.0 bar	£248.82
SET-L3625A3337-6.5	1" BSPP	6.5 bar	£248.82
SET-L3625A3337-7.0	1" BSPP	7.0 bar	£248.82
SET-L3625A3337-7.5	1" BSPP	7.5 bar	£248.82
SET-L3625A3337-8.0	1" BSPP	8.0 bar	£248.82
SET-L3625A3337-8.5	1" BSPP	8.5 bar	£248.82
SET-L3625A3337-9.0	1" BSPP	9.0 bar	£248.82
SET-L3625A3337-9.5	1" BSPP	9.5 bar	£248.82
SET-L3625A3337-10.0	1" BSPP	10.0 bar	£248.82
SET-L3625A3337-10.5	1" BSPP	10.5 bar	£248.82
SET-L3625A3337-11.0	1" BSPP	11.0 bar	£248.82
SET-L3625A3337-11.5	1" BSPP	11.5 bar	£248.82
SET-L3625A3337-12.0	1" BSPP	12.0 bar	£248.82
SET-L3625A3337-12.5	1" BSPP	12.5 bar	£248.82
SET-L3625A3337-13.0	1" BSPP	13.0 bar	£248.82
SET-L3625A3337-13.5	1" BSPP	13.5 bar	£248.82
SET-L3625A3337-14.0	1" BSPP	14.0 bar	£248.82
SET-L3625A3337-14.5	1" BSPP	14.5 bar	£248.82
SET-L3625A3337-15.0	1" BSPP	15.0 bar	£248.82

LGS™ BRONZE SAFETY VALVES DN 32 MM

PART NUMBER	INLET / OUTLET	PRESSURE	PRICE
SET-L3632A3367-0.5	1 1/4" BSPP	0.5 bar	£342.15
SET-L3632A3367-1.0	1 1/4" BSPP	1.0 bar	£342.15
SET-L3632A3367-1.5	1 1/4" BSPP	1.5 bar	£342.15
SET-L3632A3367-2.0	1 1/4" BSPP	2.0 bar	£342.15
SET-L3632A3367-2.5	1 1/4" BSPP	2.5 bar	£342.15
SET-L3632A3367-3.0	1 1/4" BSPP	3.0 bar	£342.15
SET-L3632A3367-3.5	1 1/4" BSPP	3.5 bar	£342.15
SET-L3632A3367-4.0	1 1/4" BSPP	4.0 bar	£342.15
SET-L3632A3367-4.5	1 1/4" BSPP	4.5 bar	£342.15
SET-L3632A3367-5.0	1 1/4" BSPP	5.0 bar	£342.15
SET-L3632A3367-5.5	1 1/4" BSPP	5.5 bar	£342.15
SET-L3632A3367-6.0	1 1/4" BSPP	6.0 bar	£342.15
SET-L3632A3367-6.5	1 1/4" BSPP	6.5 bar	£342.15
SET-L3632A3367-7.0	1 1/4" BSPP	7.0 bar	£342.15
SET-L3632A3367-7.5	1 1/4" BSPP	7.5 bar	£342.15
SET-L3632A3367-8.0	1 1/4" BSPP	8.0 bar	£342.15
SET-L3632A3367-8.5	1 1/4" BSPP	8.5 bar	£342.15
SET-L3632A3367-9.0	1 1/4" BSPP	9.0 bar	£342.15
SET-L3632A3367-9.5	1 1/4" BSPP	9.5 bar	£342.15
SET-L3632A3367-10.0	1 1/4" BSPP	10.0 bar	£342.15
SET-L3632A3367-10.5	1 1/4" BSPP	10.5 bar	£342.15
SET-L3632A3367-11.0	1 1/4" BSPP	11.0 bar	£342.15
SET-L3632A3367-11.5	1 1/4" BSPP	11.5 bar	£342.15
SET-L3632A3367-12.0	1 1/4" BSPP	12.0 bar	£342.15
SET-L3632A3367-12.5	1 1/4" BSPP	12.5 bar	£342.15
SET-L3632A3367-13.0	1 1/4" BSPP	13.0 bar	£342.15
SET-L3632A3367-13.5	1 1/4" BSPP	13.5 bar	£342.15
SET-L3632A3367-14.0	1 1/4" BSPP	14.0 bar	£342.15
SET-L3632A3367-14.5	1 1/4" BSPP	14.5 bar	£342.15
SET-L3632A3367-15.0	1 1/4" BSPP	15.0 bar	£342.15

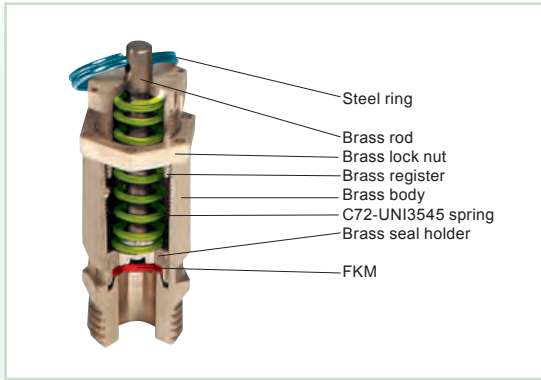

DESCRIPTION	
Safety valve with adjustable spring.	
SPECIFICATIONS	
Max. working pressure	16 bar (Series FP-200M1018.A up to 18 bar)
Temperature range	-10°C to +85°C

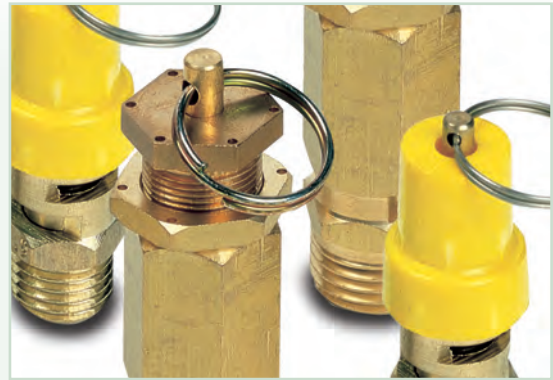

DESCRIPTION	
Pressure relief valve with set spring. Set safety valve registering is stopped by means of fixed plastic hood. It can be removed only when it's broken.	
SPECIFICATIONS	
Max. working pressure	18 bar
Temperature range	-10°C to +85°C



1925

**PRESSURE RELIEF VALVE
ADJUSTABLE
MANUAL EXHAUST RING**

PART NUMBER	THREAD	ADJUSTABLE PRESSURE	PRICE
FP-200M0002.A	1/4" BSPP	0 – 2 bar	£20.10
FP-200M0206.A	1/4" BSPP	2 – 6 bar	£20.10
FP-200M0610.A	1/4" BSPP	6 – 10 bar	£20.10
FP-200M1018.A	1/4" BSPP	10 – 18 bar	£20.10
FP-221M0002A	3/8" BSPP	0 – 2 bar	£45.66
FP-221M0208A	3/8" BSPP	2 – 8 bar	£41.98
FP-221M0816A	3/8" BSPP	8 – 16 bar	£39.94
FP-222M0002A	1/2" BSPP	0 – 2 bar	£47.70
FP-222M0208A	1/2" BSPP	2 – 8 bar	£45.66
FP-222M0816A	1/2" BSPP	8 – 16 bar	£41.98
FP-223M0002A	3/4" BSPP	0 – 2 bar	£122.37
FP-223M0208A	3/4" BSPP	2 – 8 bar	£116.77
FP-223M0816A	3/4" BSPP	8 – 16 bar	£110.92
FP-224M0004A	1" BSPP	0 – 4 bar	£160.27
FP-224M0408A	1" BSPP	4 – 8 bar	£166.63
FP-224M0816A	1" BSPP	8 – 16 bar	£161.54



1925

**PRESSURE RELIEF VALVE
SET PRESSURE
PLASTIC HOOD, MANUAL EXHAUST RING**

PART NUMBER	THREAD	SET PRESSURE	PRICE
FP-200C05.0A	1/4" BSPP	5.0 bar	£28.24
FP-200C05.5A	1/4" BSPP	5.5 bar	£28.24
FP-200C06.0A	1/4" BSPP	6.0 bar	£28.24
FP-200C06.5A	1/4" BSPP	6.5 bar	£28.24
FP-200C07.0A	1/4" BSPP	7.0 bar	£28.24
FP-200C07.5A	1/4" BSPP	7.5 bar	£28.24
FP-200C08.0A	1/4" BSPP	8.0 bar	£28.24
FP-200C08.5A	1/4" BSPP	8.5 bar	£28.24
FP-200C09.0A	1/4" BSPP	9.0 bar	£28.24
FP-200C09.5A	1/4" BSPP	9.5 bar	£28.24
FP-200C10.0A	1/4" BSPP	10.0 bar	£28.24
FP-200C11.0A	1/4" BSPP	11.0 bar	£28.24
FP-200C12.0A	1/4" BSPP	12.0 bar	£28.24

Other set pressures available upon request



Did you know?

Products with safety benefits are indicated by a chevron at the bottom of their table

Do you also need?

PARKAIR®

Air receivers



Find it on page 920, section fifteen